

Load Disconnection Function, 0.8A Step-up DC/DC Converters

☆Green Operation compatible

■GENERAL DESCRIPTION

XC9141/XC9142 series are synchronous step-up DC/DC converters with a 0.3Ω N-channel driver transistor and a 0.3Ω synchronous P-channel switching transistor built-in. A highly efficient and stable current can be supplied up to 0.8A by reducing ON resistance of the built-in transistors.

The series are able to start operation under the condition which has 0.9V input voltage to generate 3.3V output voltage with a 100Ω load resistor, suitable for mobile equipment using only one Alkaline battery or one Nickel metal hydride battery.

The output voltage can be set from 1.8V to 5.5V ($\pm 2.0\%$) in steps of 0.1V. With the built-in oscillator, either 1.2MHz or 3.0MHz can be selected for suiting to your particular application.

During the devices enter stand-by mode, A, D types prevent the application malfunction by C_L Discharge Function which can quickly discharge the electric charge at the output capacitor (C_L). B, E types is able to drive RTC etc. by Bypass Switch Function to maintain continuity between the input and output. C, F types is able to connect in output voltage OR circuit with other power supplies by Load Disconnection Function which breaks continuity between the input and output.

■APPLICATIONS

- Portable equipment
- Beauty & health equipment
- Wearable devices
- Game & Hobby
- PC Peripherals
- Devices with 1~3 Alkaline,
1~3 Nickel Hydride, 1 Lithium and 1 Li-ion

■FEATURES

Input Voltage Range	: 0.65V ~ 6.0V
Fixed Output Voltage	: 1.8V ~ 5.5V (0.1V increments)
Oscillation Frequency	: 1.2MHz, 3.0MHz
Input Current	: 0.8A
Output Current	: 500mA @ $V_{OUT}=5.0V$, $V_{BAT}=3.3V$ 330mA @ $V_{OUT}=3.3V$, $V_{BAT}=1.8V$
Control Mode Selection	: PWM (XC9141) PWM/PFM (XC9142)
Load Transient Response	: 100mV @ $V_{OUT}=3.3V$, $V_{BAT}=1.8V$, $I_{OUT}=1mA \rightarrow 200mA$ (tr=5 μ s)
Protection Circuits	: Over-current limit Integral latch method (D,E,F type) Output short-circuit protection (D,E,F type)
Functions	: Soft-start Load Disconnection (A,C,D,F type) C_L Auto Discharge (A,D type) Bypass Switch (B,E type)
Output Capacitor	: Ceramic Capacitor
Operating Ambient Temperature	: $-40^\circ\text{C} \sim 85^\circ\text{C}$
Package	: SOT-25, USP-6C, WLP-6-01
Environmentally Friendly	: EU RoHS Compliant, Pb Free

■TYPICAL APPLICATION CIRCUIT

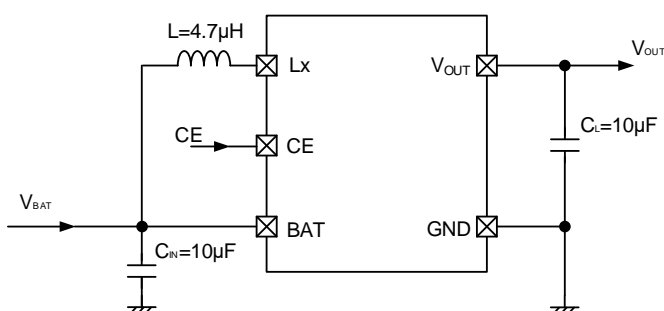

■TYPICAL PERFORMANCE CHARACTERISTICS

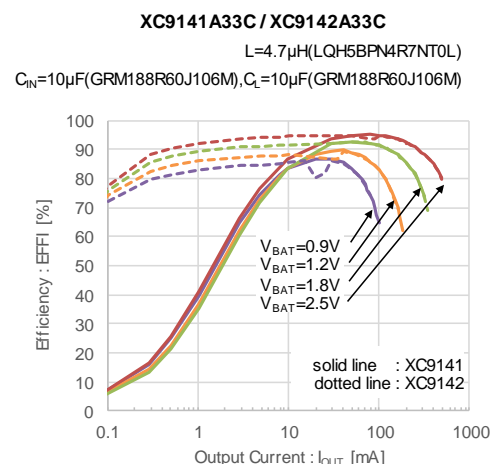

XC9141/XC9142 Series

■ BLOCK DIAGRAM

● A type

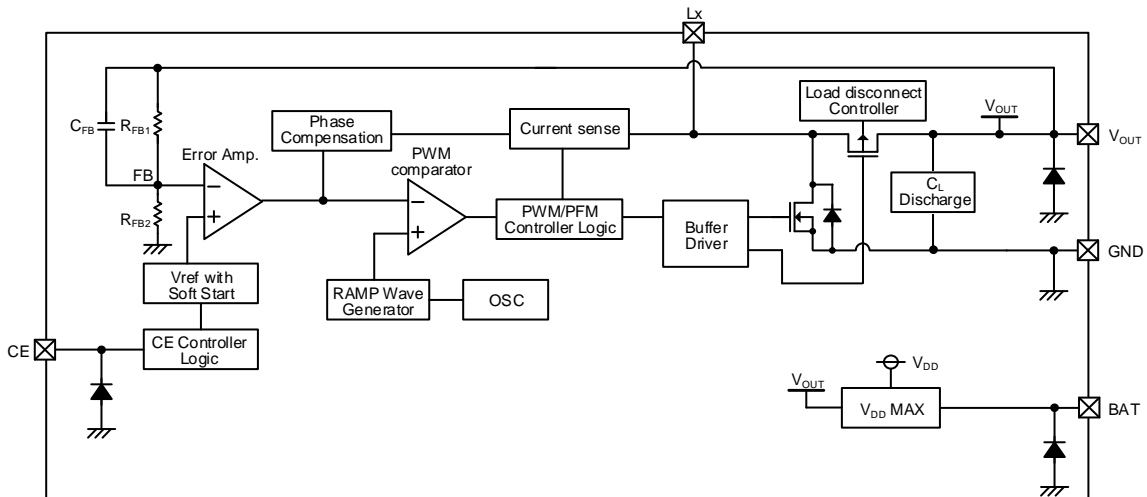

* Diodes inside the circuits are ESD protection diodes and parasitic diodes.

* XC9141 series chooses only PWM control.

● B type

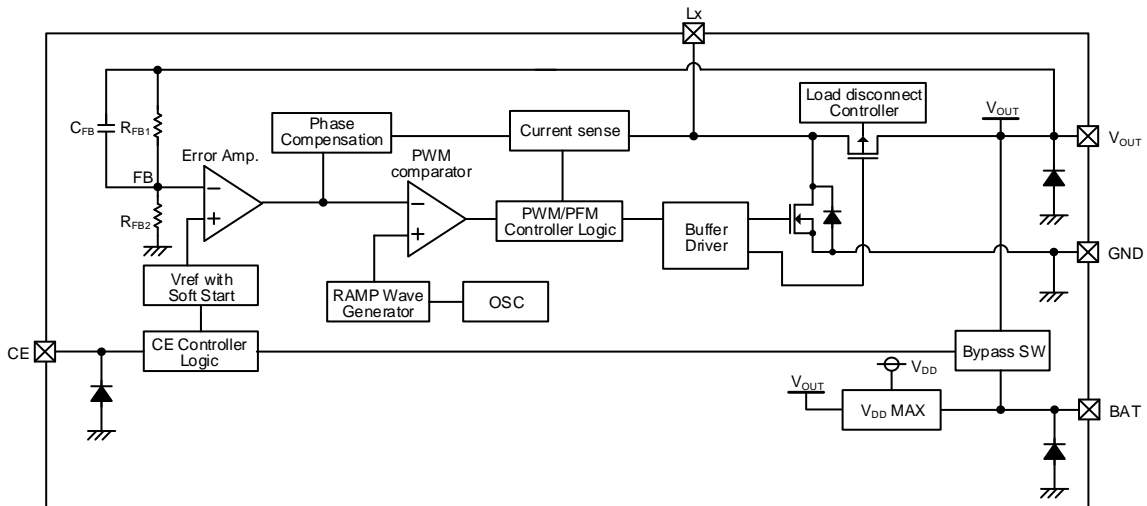

* Diodes inside the circuits are ESD protection diodes and parasitic diodes.

* XC9141 series chooses only PWM control.

● C type

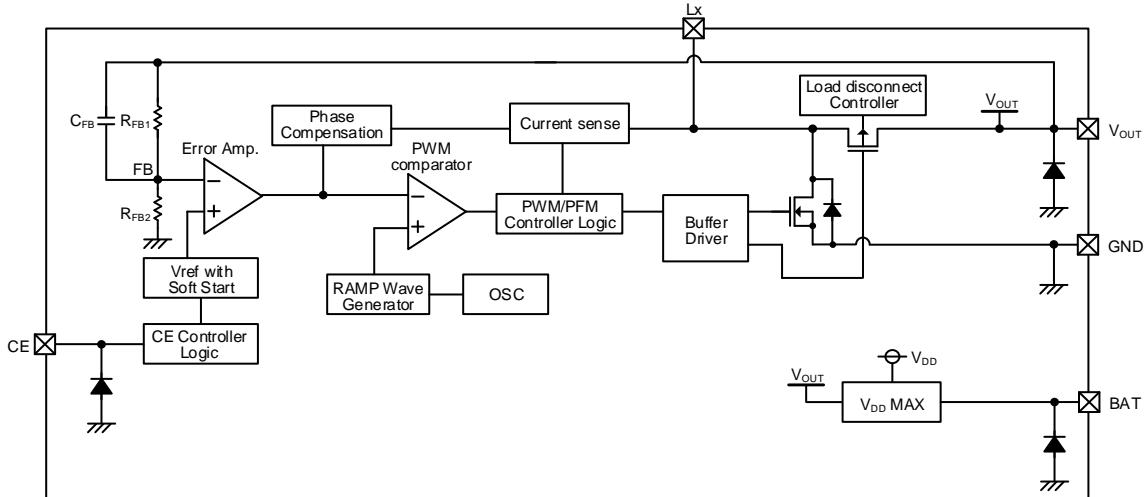

* Diodes inside the circuits are ESD protection diodes and parasitic diodes.

■ BLOCK DIAGRAM (Continued)

● D type

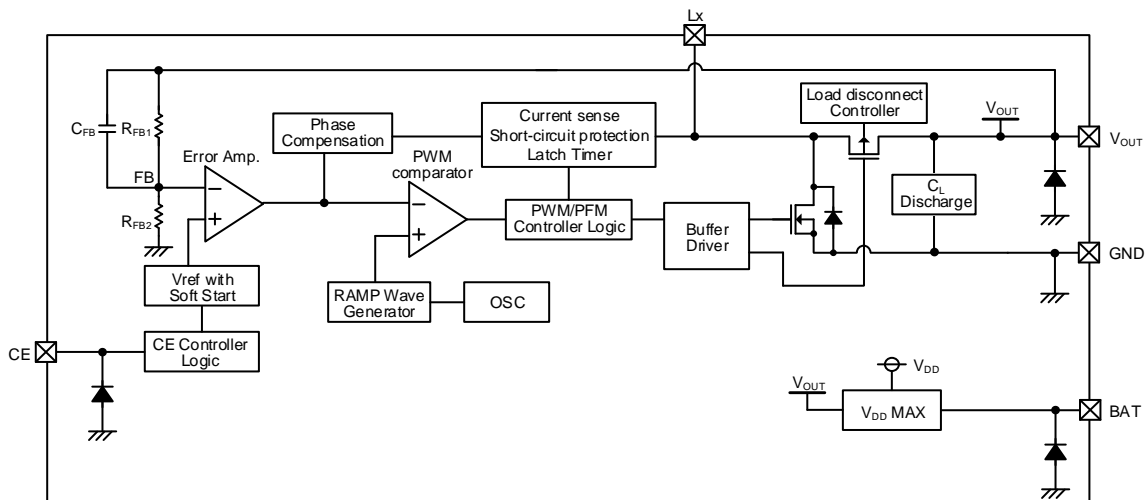

* Diodes inside the circuits are ESD protection diodes and parasitic diodes.

* XC9141 series chooses only PWM control.

● E type

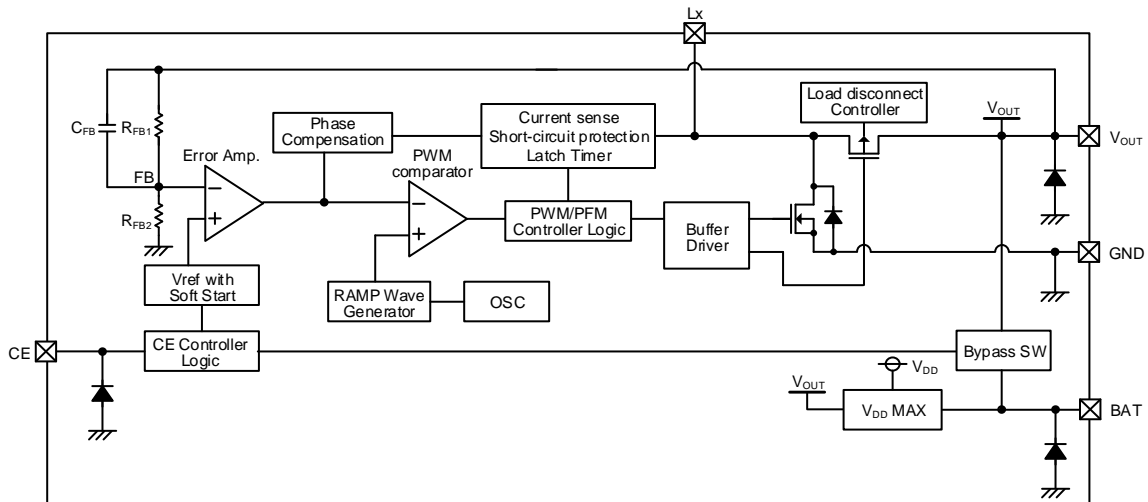

* Diodes inside the circuits are ESD protection diodes and parasitic diodes.

* XC9141 series chooses only PWM control.

● F type

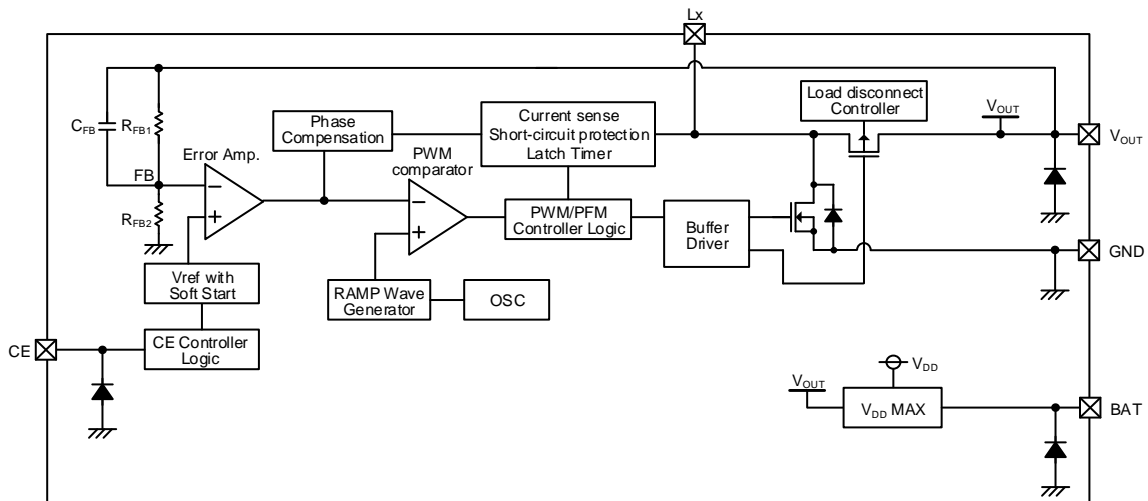

* Diodes inside the circuits are ESD protection diodes and parasitic diodes

■ PRODUCT CLASSIFICATION

● Ordering Information

XC9141①②③④⑤⑥-⑦ PWM control

DESIGNATOR	ITEM	SYMBOL	DESCRIPTION
①	Type	A	Refer to Selection Guide
		B	
		D	
		E	
②③	Output Voltage (A,B Type)	18 ~ 55	Output voltage options e.g. 1.8V → ②=1, ③=8
	Output Voltage (D,E Type)	22 ~ 55	Output voltage options e.g. 2.5V → ②=2, ③=5
④	Oscillation Frequency	C	1.2MHz
		D	3.0MHz
⑤⑥-⑦ ^(*)	Package (Order Unit)	MR-G	SOT-25 (3,000pcs/Reel)
		ER-G	USP-6C (3,000pcs/Reel)
		0R-G	WLP-6-01(5,000pcs/Reel)

^(*) The "-G" suffix indicates that the products are Halogen and Antimony free as well as being fully EU RoHS compliant.

● Selection guides

TYPE	Purpose	CL Discharge	Current Limit	Short Protection	Stand-by Options at CE="L"
A	Load Disconnection	Yes	Yes (without latch)	-	Complete Output Disconnect
D			Yes (with integral latch)	Yes	
B	Bypass Mode at CE="L"	-	Yes (without latch)	-	Input-to-Output Bypass
E			Yes (with integral latch)	Yes	

■ PRODUCT CLASSIFICATION (Continued)

XC9142①②③④⑤⑥-⑦ PWM/PFM automatic switching control

DESIGNATOR	ITEM	SYMBOL	DESCRIPTION
①	Type	A	Refer to Selection Guide
		B	
		C	
		D	
		E	
		F	
②③	Output Voltage (A,B,C Type)	18 ~ 55	Output voltage options e.g. 1.8V → ②=1, ③=8
	Output Voltage (D,E,F Type)	22 ~ 55	Output voltage options e.g. 2.5V → ②=2, ③=5
④	Oscillation Frequency	C	1.2MHz
		D	3.0MHz
⑤⑥-⑦ ^(*)	Package (Order Unit)	MR-G	SOT-25 (3,000pcs/Reel)
		ER-G	USP-6C (3,000pcs/Reel)
		0R-G	WLP-6-01(5,000pcs/Reel)

^(*) The "-G" suffix indicates that the products are Halogen and Antimony free as well as being fully EU RoHS compliant.

● Selection guides

TYPE	Purpose	CL Discharge	Current Limit	Short Protection	Stand-by Options at CE="L"
A	Load Disconnection	Yes	Yes (without latch)	-	Complete Output Disconnect
D			Yes (with integral latch)	Yes	
B	Bypass Mode at CE="L"	-	Yes (without latch)	-	Input-to-Output Bypass
E			Yes (with integral latch)	Yes	
C	V _{OUT} OR Connection	-	Yes (without latch)	-	Complete Output Disconnect
F			Yes (with integral latch)	Yes	

PIN CONFIGURATION

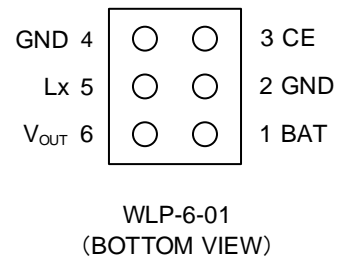
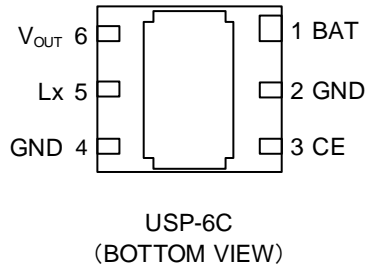
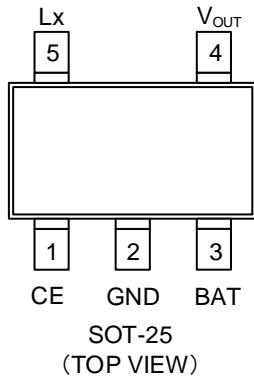

*The dissipation pad for the USP-6C package should be solder-plated in recommended mount pattern and metal masking so as to enhance mounting strength and heat release. If the pad needs to be connected to other pins, it should be connected to the GND (No.2, 4) pin.

PIN ASSIGNMENT

PIN NUMBER			PIN NAME	FUNCTIONS
SOT-25	USP-6C	WLP-6-01		
1	3	3	CE	Chip Enable
2	2	2	GND	Ground
3	1	1	BAT	Power Input
4	6	6	V _{OUT}	Output Voltage
5	5	5	Lx	Switching
-	4	4	GND	Ground

FUNCTION CHART

PIN NAME	SIGNAL	STATUS
CE	L	Stand-by
	H	Active

* Do not leave the CE pin open.

ABSOLUTE MAXIMUM RATINGS

				Ta=25°C
PARAMETER	SYMBOL	RATINGS	UNITS	
BAT Pin Voltage	V _{BAT}	-0.3 ~ 7.0	V	
Lx Pin Voltage	V _{Lx}	-0.3 ~ 7.0	V	
V _{OUT} Pin Voltage	V _{OUT}	-0.3 ~ 7.0	V	
CE Pin Voltage	V _{CE}	-0.3 ~ 7.0	V	
Power Dissipation	SOT-25	Pd	600 (40mm x 40mm 標準基板) ^(*)	mW
			760 (JESD51-7 基板) ^(*)	
			1000 (40mm x 40mm 標準基板) ^(*)	
			1250 (JESD51-7 基板) ^(*)	
	WLP-6-01		700 (40mm x 40mm 標準基板) ^(*)	
Operating Ambient Temperature	Topr	-40 ~ 85	°C	
Storage Temperature	Tstg	-55 ~ 125	°C	

* GND are standard voltage for all of the voltage.

^(*) This power dissipation figure shown is PCB mounted and is for reference only.

Please refer to PACKAGING INFORMATION for the mounting condition.

ELECTRICAL CHARACTERISTICS

Ta=25°C

PARAMETER	SYMBOL	CONDITIONS		MIN.	TYP.	MAX.	UNITS	CIRCUIT
Input Voltage	V _{BAT}			-	-	6.0	V	①
Output Voltage	V _{OUT}	Voltage to start oscillation while V _{OUT} =V _{OUT(T)} × 1.03 → V _{OUT(T)} × 0.97		<E-1>	<E-2>	<E-3>	V	⑤
Operation Start Voltage	V _{ST1}	R _L =1kΩ		-	-	0.90	V	①
Operation Hold Voltage	V _{HLD}	R _L =1kΩ		-	0.65	-	V	①
Quiescent Current (XC9142)	I _q	V _{OUT} =V _{BAT} = V _{OUT(T)} +0.5V	f _{OSC} =1.2MHz	-	17.0	30.0	μA	③
			f _{OSC} =3.0MHz	-	26.0	40.0		
Supply Current	I _{DD}	V _{OUT} =V _{BAT} = V _{OUT(T)} -0.2V	f _{OSC} =1.2MHz	-	<E-4>	1.500	mA	③
			f _{OSC} =3.0MHz	-	<E-5>	3.000		
Oscillation Frequency	f _{OSC}	V _{BAT} = V _{OUT(T)} ×0.5 I _{OUT} =100mA	f _{OSC} =1.2MHz	1.02	1.20	1.38	MHz	①
			f _{OSC} =3.0MHz	2.40	3.00	3.60		
Maximum Duty Cycle	D _{MAX}	V _{BAT} =1.2V, V _{OUT} = V _{OUT(T)} -0.2V	f _{OSC} =1.2MHz	85	93	98	%	⑤
			f _{OSC} =3.0MHz	88	93	98		
Minimum Duty Cycle	D _{MIN}	V _{OUT} =V _{BAT} = V _{OUT(T)} +0.5V		-	-	0	%	⑤
PFM Switching Current	I _{PFM}	V _{BAT} =1.5V, R _L is selected with V _{OUT(T)} , Refer to Table 1.		-	165	230	mA	①
Efficiency (XC9142)	EFFI	V _{BAT} = V _{OUT(T)} ×0.6, R _L is selected with V _{OUT(T)} , Refer to Table 1.		-	86 ^{(*)3}	-	%	①
Efficiency	EFFI	V _{BAT} = V _{OUT(T)} ×0.6, I _{OUT} = 100mA		-	90 ^{(*)3}	-		①
Stand-by Current	I _{STB}	V _{BAT} =V _{Lx} =6.0V, V _{CE} =0.0V ^{(*)1}	A,B,D,E Type	-	0.0	1.0	μA	⑦
			C,F Type	-	1.0	2.4		⑧
Lx SW "Pch" ON Resistance	R _{LXP}	V _{BAT} =V _{Lx} = 6.0V, I _{OUT} =200mA		-	0.3 ^{(*)2}	-	Ω	④
Lx SW "Nch" ON Resistance	R _{LXN}			-	0.3 ^{(*)3}	-	Ω	①
Lx SW"H" Leakage Current	I _{LXLH}	V _{BAT} =6.0V, V _{CE} =0.0V, V _{Lx} =6.0V ^{(*)1}	A,B,D,E Type	-	0.0	1.0	μA	⑦
			C,F Type	-	0.0	1.0		⑧
Lx SW"L" Leakage Current (XC9142C/F)	I _{LXLL}	V _{BAT} =0.0V, V _{CE} =0.0V, V _{Lx} =0.0V, V _{OUT} =6.0V		-	0.0	1.0	μA	②
Current Limit	I _{LIM}	V _{BAT} = V _{OUT(T)} -0.2V, R _{Lx} =1Ω		<E-6>	<E-7>	<E-8>	A	⑥
Integral Latch Time (D,E,F Type)	t _{LAT}	V _{BAT} = V _{OUT(T)} -0.2V, R _{Lx} =1Ω, Time from current limit start to stop Lx oscillation	f _{OSC} =1.2MHz	45	300	725	μs	⑥
			f _{OSC} =3.0MHz	25	100	365	μs	⑥
Latch Release Voltage (D,E,F Type)	V _{LAT_R}	After the integral latch was operated, R _L is selected with V _{OUT(T)} , Refer to Table 1 V _{BAT} =V _{OUT(T)} -0.2V → 0.9V		0.9	1.2	1.5	V	①
Short-circuit Protection Threshold Voltage (D,E,F Type)	V _{SHORT}	V _{BAT} =V _{OUT(T)} -0.2V, R _L =0Ω		-	V _{BAT} ^{(*)3}	-	V	①

ELECTRICAL CHARACTERISTICS (Continued)

PARAMETER	SYMBOL	CONDITIONS	MIN.	TYP.	MAX.	UNITS	CIRCUIT	
Soft-Start Time	t_{SS}	$V_{BAT} = V_{OUT(T)} \times 0.6$, $V_{OUT} = V_{OUT(T)} \times 0.9$, After "H" is fed to CE, the time by when clocks are generated at Lx pin.	$f_{OSC} = 1.2\text{MHz}$	0.6	1.0	2.5	ms	⑤
			$f_{OSC} = 3.0\text{MHz}$	0.2	0.5	1.0		
C_L Discharge Resistance (A,D Type)	R_{DCHG}	$V_{BAT} = 3.3\text{V}, V_{OUT} = 3.3\text{V}, V_{CE} = 0.0\text{V}$	100	180	400	Ω	②	
Bypass SW Resistance (B,E Type)	R_{BSW}	$V_{BAT} = 3.3\text{V}, V_{OUT} = 0.0\text{V}, V_{CE} = 0.0\text{V}$	100	180	400	Ω	②	
CE "H" Voltage	V_{CEH}	$V_{OUT} = V_{OUT(T)} - 0.15\text{V}$, Applied voltage to V_{CE} , Voltage changes Lx to be generated.	0.80	-	6.00	V	⑤	
CE "L" Voltage	V_{CEL}	$V_{OUT} = V_{OUT(T)} - 0.15\text{V}$, Applied voltage to V_{CE} , Voltage changes Lx to "H" level.	GND	-	0.20	V	⑤	
CE "H" Current	I_{CEH}	$V_{BAT} = 6.0\text{V}, V_{OUT} = 6.0\text{V}, V_{Lx} = 6.0\text{V}, V_{CE} = 6.0\text{V}$	-0.1	-	0.1	μA	②	
CE "L" Current	I_{CEL}	$V_{BAT} = 6.0\text{V}, V_{OUT} = 6.0\text{V}, V_{Lx} = 6.0\text{V}, V_{CE} = 0.0\text{V}$	-0.1	-	0.1	μA	②	

$V_{OUT(T)}$ = Target voltage

Test Conditions: unless otherwise stated, $V_{BAT} = 1.5\text{V}$, $V_{ce} = 3.3\text{V}$, Lx: OPEN, $R_{Lx} = 56\Omega$

(¹) XC9141A/D, XC9142A/D, XC9142C/F type: $V_{OUT} = 0\text{V}$,

XC9141B/E, XC9142B/E type: $V_{OUT} = \text{OPEN}$

(²) Design value for the XC9142C/F type.

(³) Designed value

Table 1. External Components R_L Table

$V_{OUT(T)}$	R_L
UNITS: V	UNITS: Ω
$1.8 \leq V_{OUT(T)} < 2.1$	150
$2.1 \leq V_{OUT(T)} < 3.1$	220
$3.1 \leq V_{OUT(T)} < 4.3$	330
$4.3 \leq V_{OUT(T)} \leq 5.5$	470

■ ELECTRICAL CHARACTERISTICS (Continued)

Table 2: SPEC Table

NOMINAL OUTPUT VOLTAGE	V _{OUT}			I _{DD}		I _{LIM}		
				f _{OSC} =1.2MHz	f _{OSC} =3.0MHz			
	<E-1>	<E-2>	<E-3>	<E-4>	<E-5>	<E-6>	<E-7>	<E-8>
UNITS	V	V	V	mA	mA	A	A	A
V _{OUT(T)}	MIN.	TYP.	MAX.	TYP.	TYP.	MIN.	TYP.	MAX.
1.8	1.764	1.800	1.836	0.263	0.583	-	0.96	2.30
1.9	1.862	1.900	1.938	0.279	0.614	-	1.00	2.30
2.0	1.960	2.000	2.040	0.296	0.644	-	1.04	2.30
2.1	2.058	2.100	2.142	0.312	0.675	-	1.07	2.30
2.2	2.156	2.200	2.244	0.328	0.705	-	1.11	2.30
2.3	2.254	2.300	2.346	0.344	0.736	-	1.14	2.30
2.4	2.352	2.400	2.448	0.360	0.767	-	1.17	2.30
2.5	2.450	2.500	2.550	0.376	0.797	-	1.19	2.30
2.6	2.548	2.600	2.652	0.393	0.828	-	1.22	2.30
2.7	2.646	2.700	2.754	0.409	0.858	-	1.24	2.30
2.8	2.744	2.800	2.856	0.425	0.889	-	1.26	2.30
2.9	2.842	2.900	2.958	0.441	0.919	-	1.28	2.30
3.0	2.940	3.000	3.060	0.457	0.950	0.96	1.30	2.30
3.1	3.038	3.100	3.162	0.474	0.981	0.97	1.30	2.30
3.2	3.136	3.200	3.264	0.490	1.011	0.97	1.30	2.30
3.3	3.234	3.300	3.366	0.506	1.042	0.98	1.30	2.30
3.4	3.332	3.400	3.468	0.522	1.072	0.98	1.30	2.30
3.5	3.430	3.500	3.570	0.538	1.103	0.99	1.30	2.30
3.6	3.528	3.600	3.672	0.554	1.134	0.99	1.30	2.30
3.7	3.626	3.700	3.774	0.571	1.164	1.00	1.30	2.30
3.8	3.724	3.800	3.876	0.587	1.195	1.00	1.30	2.30
3.9	3.822	3.900	3.978	0.603	1.225	1.01	1.30	2.30
4.0	3.920	4.000	4.080	0.619	1.256	1.01	1.30	2.30
4.1	4.018	4.100	4.182	0.635	1.286	1.02	1.30	2.30
4.2	4.116	4.200	4.284	0.652	1.317	1.02	1.30	2.30
4.3	4.214	4.300	4.386	0.668	1.348	1.03	1.30	2.30
4.4	4.312	4.400	4.488	0.684	1.378	1.03	1.30	2.30
4.5	4.410	4.500	4.590	0.700	1.409	1.04	1.30	2.30
4.6	4.508	4.600	4.692	0.716	1.439	1.04	1.30	2.30
4.7	4.606	4.700	4.794	0.732	1.470	1.05	1.30	2.30
4.8	4.704	4.800	4.896	0.749	1.501	1.06	1.30	2.30
4.9	4.802	4.900	4.998	0.765	1.531	1.06	1.30	2.30
5.0	4.900	5.000	5.100	0.781	1.562	1.07	1.30	2.30
5.1	4.998	5.100	5.202	0.797	1.592	1.07	1.30	2.30
5.2	5.096	5.200	5.304	0.813	1.623	1.08	1.30	2.30
5.3	5.194	5.300	5.406	0.829	1.653	1.08	1.30	2.30
5.4	5.292	5.400	5.508	0.846	1.684	1.09	1.30	2.30
5.5	5.390	5.500	5.610	0.862	1.715	1.09	1.30	2.30

TEST CIRCUITS

< Circuit No.① >

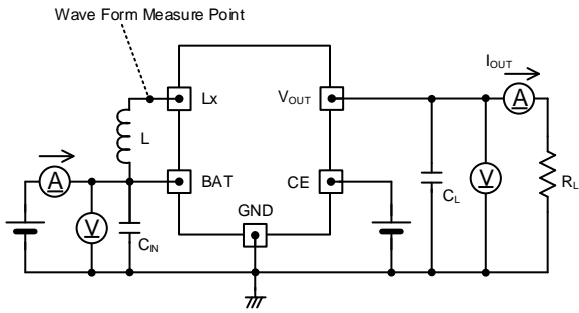

※External Components
 C_N : 10 μ F (ceramic)
 C_L : 10 μ F (ceramic)
 XC914xxxxC ($f_{OSC} = 1.2\text{MHz}$)
 L : 4.7 μ H
 XC914xxxxD ($f_{OSC} = 3.0\text{MHz}$)
 L : 2.2 μ H

< Circuit No.② >

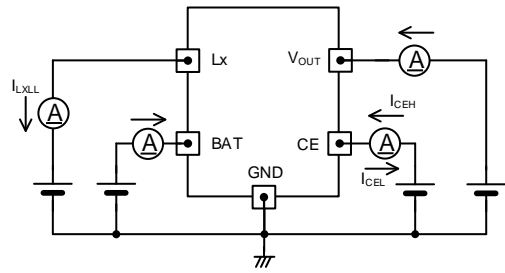

< Circuit No.③ >

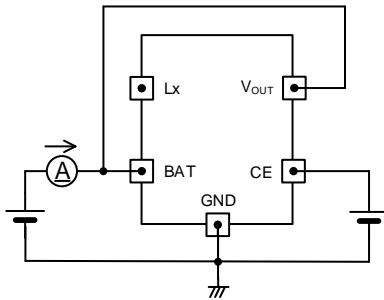

< Circuit No.④ >

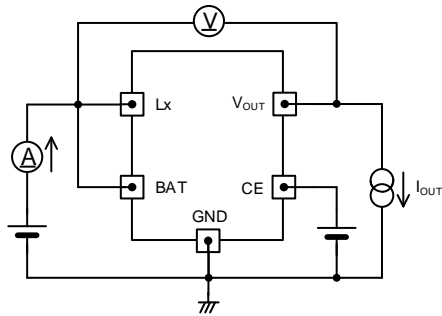

< Circuit No.⑤ >

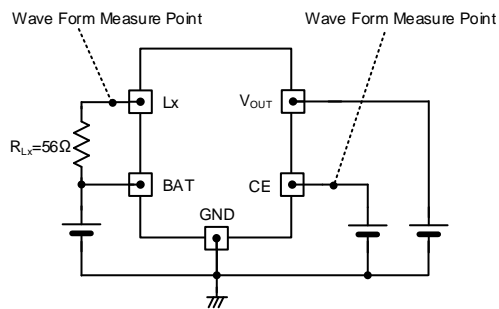

< Circuit No.⑥ >

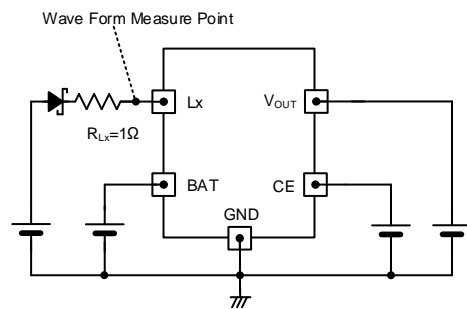

< Circuit No.⑦ >

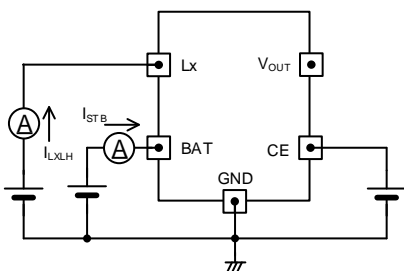

< Circuit No.⑧ >

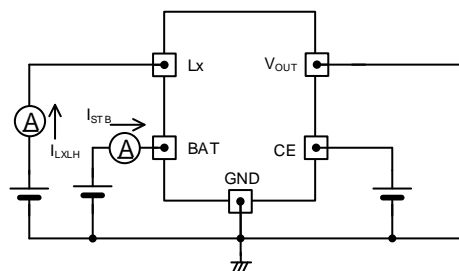

TYPICAL APPLICATION CIRCUIT

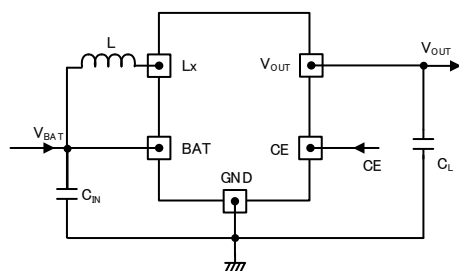

【Typical Examples】 $f_{osc}=1.2\text{MHz}$

	MANUFACTURER	PRODUCT NUMBER	VALUE
L	murata	LQH5BPN4R7NT0L	4.7 μH
	TDK	LTF5022T-4R7N2R0-LC	4.7 μH
	Coilcraft	XFL4020-472MEC	4.7 μH
$C_L^{(*)1}$	murata	GRM188R60J106ME84	10 $\mu\text{F}/6.3\text{V}^{(*)2}$
	murata	GRM188D71A106MA73	10 $\mu\text{F}/10\text{V}^{(*)2}$

【Typical Examples】 $f_{osc}=3.0\text{MHz}$

	MANUFACTURER	PRODUCT NUMBER	VALUE
L	TDK	LTF5022T-2R2N3R2-LC	2.2 μH
	Coilcraft	XFL4020-222MEC	2.2 μH
$C_L^{(*)1}$	murata	GRM188R60J106ME84	10 $\mu\text{F}/6.3\text{V}^{(*)2}$
	murata	GRM188D71A106MA73	10 $\mu\text{F}/10\text{V}^{(*)2}$

【Typical Examples】 $f_{osc}=1.2\text{MHz}$, $f_{osc}=3.0\text{MHz}$

	MANUFACTURER	PRODUCT NUMBER	VALUE
$C_{IN}^{(*)1}$	murata	GRM188R60J106ME84	10 $\mu\text{F}/6.3\text{V}$
	murata	GRM188D71A106MA73	10 $\mu\text{F}/10\text{V}$

(*)1 Select components appropriate to the usage conditions (ambient temperature, input & output voltage).

While selecting a part, please concern about capacitance reduction and voltage durability.

(*)2 In the case of $f_{osc}=1.2\text{MHz}$: If $V_{OUT(T)} \geq 3.5\text{V}$ and the load current rises above 200mA, use two or more in a parallel connection.

In the case of $f_{osc}=3.0\text{MHz}$: If $V_{BAT} \geq 2\text{V}$, $V_{OUT(T)} \geq 3.5\text{V}$ and the load current rises above 200mA, use two or more in a parallel connection.

For the actual load capacitance, use a ceramic capacitor that ensures a capacitance equivalent to or greater than the GRM188R60J106ME84 (Murata).

If using tantalum or low ESR electrolytic capacitors please be aware that ripple voltage will be higher due to the larger ESR (Equivalent Series Resistance) values of those types of capacitors. Please also note that the IC's operation may become unstable with such capacitors so that we recommend to test on the board before usage.

If using electrolytic capacitor for the C_L , please connect a ceramic capacitor in parallel.

OPERATIONAL EXPLANATION

The XC9141/XC9142 series consists of a reference voltage source, ramp wave circuit, error amplifier, PWM comparator, phase compensation circuit, N-channel driver transistor, P-channel synchronous rectification switching transistor and current limiter circuit.

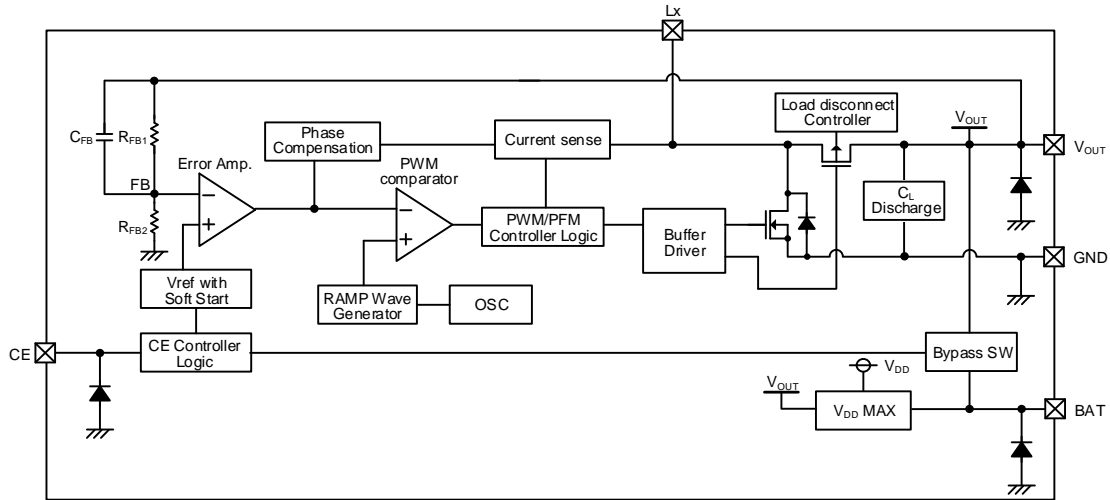

BLOCK DIAGRAM

The error amplifier compares the internal reference voltage with the resistors R_{FB1} and R_{FB2} . Phase compensation is performed on the resulting error amplifier output, to input a signal to the PWM comparator to determine the turn-on time of the N-channel driver transistor during PWM operation.

The PWM comparator compares, in terms of voltage level, the signal from the error amplifier with the ramp wave from the ramp wave circuit, and delivers the resulting output to the buffer driver circuit to cause the Lx pin to output a switching duty cycle. This process is continuously performed to ensure stable output voltage.

The current feedback circuit monitors the N-channel driver transistor's turn-on current for each switching operation, and modulates the error amplifier output signal to provide multiple feedback signals. This enables a stable feedback loop even when a low ESR capacitor, such as a ceramic capacitor, is used, ensuring stable output voltage.

<Reference voltage source, soft start function>

The reference voltage forms a reference that is used to stabilize the output voltage of the IC.

After "H" level is fed to CE pin, the reference voltage connected to the error amp increases linearly during the soft start interval. This allows the voltage divided by the internal R_{FB1} and R_{FB2} resistors and the reference voltage to be controlled in a balanced manner, and the output voltage rises in proportion to the rise in the reference voltage. This operation prevents rush input current and enables the output voltage to rise smoothly.

<Ramp Wave Circuit>

The ramp wave circuit determines switching frequency. The frequency is fixed internally at 1.2MHz/3.0MHz. The Clock generated is used to produce ramp waveforms needed for PWM operation, and to synchronize all the internal circuits.

<Error Amplifier>

The error amplifier is designed to monitor output voltage. The amplifier compares the reference voltage with the feedback voltage divided by the internal resistors (R_{FB1} and R_{FB2}). When the FB is lower than the reference voltage, output voltage of the error amplifier increases. The gain and frequency characteristics of the error amplifier are optimized internally.

< V_{DDMAX} >

V_{DDMAX} circuit compares the input voltage and the output voltage then it will select the higher one as the power supply for the IC.

<Shutdown function, load disconnection function>

The IC enters chip disable state by applying low level voltage to the CE pin. At this time, the N-channel and P-channel synchronous switching transistors are turned OFF. With XC9142C type, the load disconnection function activates even during shutdown, and because the input voltage V_{BAT} and output voltage V_{OUT} are compared to optimally control the orientation of the parasitic diode of the P-channel synchronous switching transistor, a parallel connection with other power supplies is possible.

With the XC9141 series and XC9142A/B types, the orientation of the parasitic diode of the P-channel synchronous switching transistor is fixed at anode: V_{OUT} and cathode: Lx during shutdown to break conduction from the input side to the output side by the parasitic diode of the P-channel synchronous switching transistor.

<PWM/PFM control circuit>

When PFM operates, the N-channel driver transistor turns on at the timing of the signal sent from the PWM comparator. The N-channel driver transistor remains on until the current in the coil reaches a constant current (I_{PFM}).

The PWM/PFM control circuit compares the signal sent from the PWM comparator to the time it takes the current in the coil to reach a constant current (I_{PFM}), and outputs the pulse that results in a longer on-time of the N-channel driver transistor. This enables smooth switching between PWM and PFM.

The XC9141 series directly outputs the signal that is sent from the PWM comparator.

■ OPERATIONAL EXPLANATION (Continued)

<Maximum current limit function, short-circuit protection>

The maximum current limit function of XC9141A/B types and XC9142A/B/C types constantly monitors the current flowing in the N-channel driver transistor connected to the Lx pin, and if the current in the N-channel driver transistor exceeds the current limit, the function turns off the N-channel driver transistor. (Please refer to Fig. I_{LIM}①)

- ① If the current flowing in the N-channel driver transistor exceeds the current limit value (equivalent to the peak coil current), the N-channel driver transistor turns off, and remains off during the clock interval.
- ② At the next clock, the N-channel driver transistor turns on.

If overcurrent continues, ① and ② are repeated.

Note that the current in the internal N-channel driver transistor is not the same as the output current I_{OUT}.

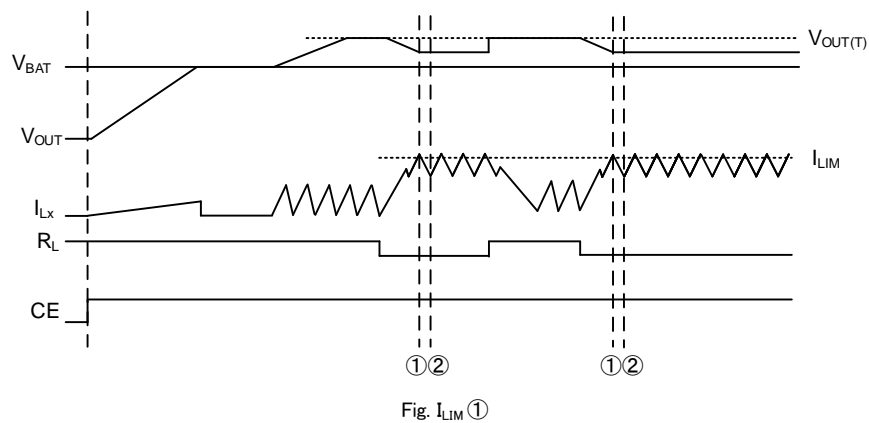

OPERATIONAL EXPLANATION (Continued)

<Maximum current limit function, short-circuit protection(Continued)>

The maximum current limit function of XC9141D/E and XC9142D/E/F types monitors the current that flows in the N-channel driver transistor connected to the Lx pin, and consists of both maximum current limiting and a latch function. (Please refer to Fig.I_{LIM}(2))

Short-circuit protection is a latch-stop function that activates when the output voltage drops below the short-circuit protection threshold voltage in the overcurrent state. (Please refer to Fig.I_{LIM}(3))

- ① If the current flowing in the N-channel driver transistor exceeds the current limit value (equivalent to the peak coil current), the N-channel driver transistor turns off, and remains off during the clock interval. In addition, an integral latch timer starts the count.
- ② The N-channel driver transistor turns on at the next pulse. If in the overcurrent state at this time, the N-channel driver transistor turns off as in (1). The integral latch timer continues the count.
- ③ If the count of the integral latch timer continues for 300μs typ. (@fosc=1.2MHz), a function that latches the N-channel driver transistor and P-channel synchronous switching transistor to the off state activates.
- ④ If no longer in the overcurrent state at the next pulse, normal operation resumes. The integral latch timer stops the count.

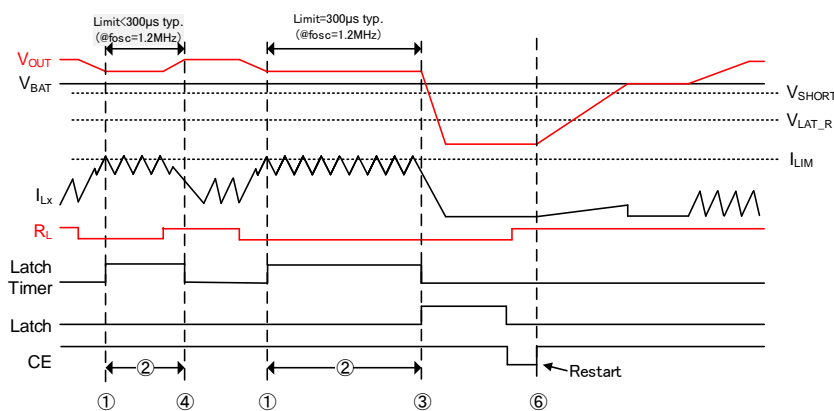

Fig. I_{LIM} ②

- ⑤ If the output voltage V_{OUT} drops below the short-circuit protection threshold voltage V_{SHORT} during the count of the integral latch timer, a function that latches the N-channel driver transistor and P-channel synchronous switching transistor in the off state activates. The short-circuit protection threshold voltage V_{SHORT} is a threshold voltage that is linked to the input voltage V_{BAT}.
- ⑥ In the latched state, either restart by shutting down once with the CE pin, or resume operation by lowering the input voltage V_{BAT} below the latch release voltage V_{LAT_R}(1.2V typ.). The soft start function operates during restart. During the soft-start interval t_{SS}, the integral latch timer and latch function are stopped.
- ⑦ When the input voltage V_{BAT} is below the latch release voltage V_{LAT_R}(1.2V typ.), the integral latch timer and latch function stop, but the current limiting function continues operating.

* Note that the current in the internal N-channel driver transistor is not the same as the output current I_{OUT}.

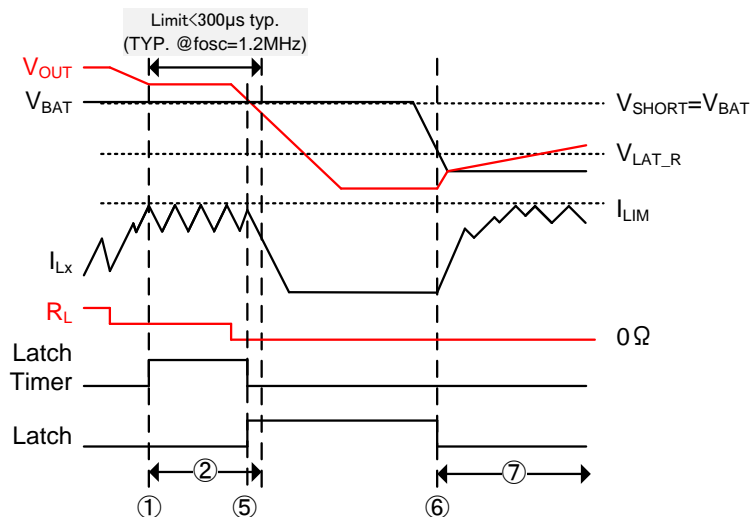

Fig. I_{LIM} ③

■ OPERATIONAL EXPLANATION (Continued)

<C_L Discharge>

The XC9141A/D type and XC9142A/D type can discharge the electric charge at the output capacitor (C_L) when a low signal to the CE pin which enables a whole IC circuit put into OFF state, is inputted via the N-channel transistor located between the V_{OUT} pin and the GND pin. When the IC is disabled, electric charge at the output capacitor (C_L) is quickly discharged so that it may avoid application malfunction. Discharge time of the output capacitor (C_L) is set by the C_L auto-discharge resistance (R) and the output capacitor (C_L). By setting time constant of a C_L auto-discharge resistance value [R_{DCHG}] and an output capacitor value (C_L) as τ ($\tau = C_L \times R_{DCHG}$), discharge time of the output voltage after discharge via the N channel transistor is calculated by the following formulas. However, the C_L discharge resistance [R_{DCHG}] is depends on the V_{BAT} or V_{OUT}. We recommend that you fully check actual performance.

$$V = V_{OUT} \times e^{-t/\tau} \quad \text{or} \quad t = \tau \times \ln(V_{OUT}/V)$$

- V : Output voltage after discharge
- V_{OUT(T)} : Target voltage
- t : Discharge time
- τ : C_L × R_{DCHG}
- C_L : Capacitance of Output capacitor (C_L)
- R_{DCHG} : C_L Discharge resistance, it depends on supply voltage

Output Voltage Discharge characteristics

$$R_{DCHG} = 180\Omega(\text{TYP}) \quad C_L = 10\mu\text{F}$$

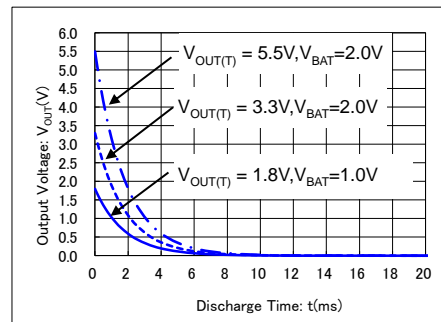

<Bypass switch>

At shutdown, XC9141B/E type and XC9142B/E type conduct between the BAT pin and V_{OUT} pin by means of a bypass switch. If the output is shorted to ground, the current is limited by the resistance (R_{BSW}) of the bypass switch.

NOTE ON USE

- 1) For the phenomenon of temporal and transitional voltage decrease or voltage increase, the IC may be damaged or deteriorated if IC is used beyond the absolute maximum ratings.
- 2) Spike noise and ripple voltage arise in a switching regulator as with a DC/DC converter. These are greatly influenced by external component selection, such as the coil inductance, capacitance values, and board layout of external components. Once the design has been completed, verification with actual components should be done.
- 3) The DC/DC converter performance is greatly influenced by not only the ICs' characteristics, but also by those of the external components. Care must be taken when selecting the external components. Especially for C_L load capacitor, it is recommended to use type B capacitors (JIS regulation) or X7R, X5R capacitors (EIA regulation).
- 4) Use a ground wire of sufficient strength. Ground potential fluctuation caused by the ground current during switching could cause the IC operation to become unstable, so reinforce the area around the GND pin of the IC in particular.
- 5) Please mount each external component as close to the IC as possible. Also, please make traces thick and short to reduce the circuit impedance.
- 6) With regard to the current limiting value (I_{LIM}), the actual coil current may at times exceed the electrical characteristics due to propagation delay inside the product.
- 7) The CE pin is a CMOS input pin. Do not use with the pin open. If connecting to the BAT pin or ground pin, use the resistor which is $1M\Omega$ or less. To prevent malfunctioning of the device connected to this product or the input/output due to short circuiting between pins, it is recommended that a resistor be connected.
- 8) In case of connecting to another power supply as shown in below circuit diagram, please use the XC9142C/F type. Connecting another external power supply to the output of any other type may destroy the IC.
- 9) The maximum current limiter controls the limit of the N-channel driver transistor by monitoring current flow. This function does not limit the current flow of the P-channel synchronous transistor. When used with the condition $V_{BAT} > V_{OUT}$ (input voltage higher than the output voltage), the IC may be destroyed if overcurrent flows to the P-channel synchronous switching transistor due to short-circuiting of the load or other reason.
- 10) When the device is used in high step-up ratio, the current limit function may not work during excessive load current. In this case, the maximum duty cycle limits maximum current. In this event, latching may not take place on XC9141D/E types and XC9142D/E/F types ("latch types" below) because the maximum current limit cannot be detected.
- 11) On latch types, some board conditions may cause release from the maximum current limit, and the integrated latch time may become longer or latching may not take place.
- 12) If the status heavy load and large output capacitor is connected or the input voltage is low, the output voltage may overshoot, on XC9141A/B types and XC9142A/B/C types ("non-latch types" below). On a latch type, the maximum current limit may be detected, and this will cause the latch function to activate and stop operation after the soft start time elapses. In particular, note that the soft start time becomes shorter when the IC is used at high temperatures.
- 13) When the step-up voltage difference is small, the XC9141 series for PWM control may oscillate intermittently.
- 14) When the voltage boost difference is small, the current limiting function may not operate if the on time of the N-channel driver transistor is shorter than the propagation delay time of the current limit circuit. In this case, latching may not take place on a latch type because the maximum current limit is not detected.
- 15) When an XC9142C/F type is used with $V_{BAT} > V_{OUT(T)}$ (input voltage higher than the set output voltage), the P-channel synchronous switching transistor turns off but current flows to the parasitic diode. This causes excessive heat generation in the IC. Test using the actual equipment and note the power dissipation and heat dissipation of the package. During voltage boosting with a voltage drop due to V_F of the parasitic diode, the output voltage may become unstable. On the XC9141 series and XC9142A/B/D/E types, the P-channel synchronous switching transistor turns on and the output voltage becomes equal to the input voltage. In environments where $V_{BAT} > V_{OUT(T)}$, the XC9141 series and XC9142A/B/D/E types are recommended.
- 16) When input voltage and output voltage are low, integral latch function and short-circuit protection may not operate. We recommend that you fully check actual performance.
- 17) TOREX places an importance on improving our products and its reliability. However, by any possibility, we would request user fail-safe design and post-aging treatment on system or equipment.

■ NOTE ON USE (Continued)

18) Note on mounting (WLP-6-01)

1. Mount pad design should be optimized for user's conditions.
2. Sn-AG-Cu is used for the package terminals. If eutectic solder is used, mounting reliability is decreased. Please do not use eutectic solder paste.
3. When underfill agent is used to increase interfacial bonding strength, please take enough evaluation for selection. Some underfill materials and applied conditions may decrease bonding reliability.
4. The IC has exposed surface of silicon material in the top marking face and sides so that it is weak against mechanical damages. Please take care of handling to avoid cracks and breaks.
5. The IC has exposed surface of silicon material in the top marking face and sides. Please use the IC with keeping the circuit open (avoiding short-circuit from the out).
6. Semi-transparent resin is coated on the circuit face of the package. Please be noted that the usage under strong lights may affects device performance.

● Instructions for pattern layouts

1. In order to stabilize V_{BAT} voltage level, we recommend that a by-pass capacitor C_{IN} is connected as close as possible to the BAT and GND pins.
2. Please mount each external component as close to the IC as possible.
3. Place external components as close to the IC as possible and use thick and short traces to reduce the circuit impedance.
4. Make sure that the PCB GND traces are thick and wide as possible. GND voltage level fluctuation created by high ground current at the time of switching may cause instability of the IC.
5. The internal driver transistors bring on heat because of the I_{IN} current and ON resistance of the driver transistors.

XC9141/XC9142 Series

<Example of pattern layout>

SOT-25

Layer 1

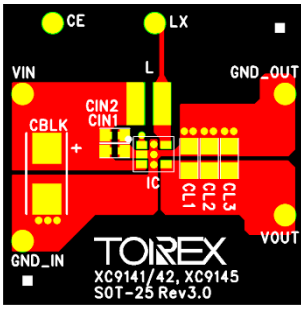

Layer 2

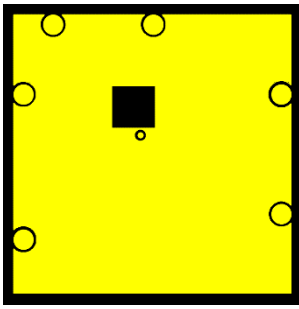

Layer 3

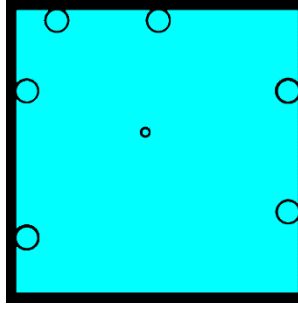

Layer 4

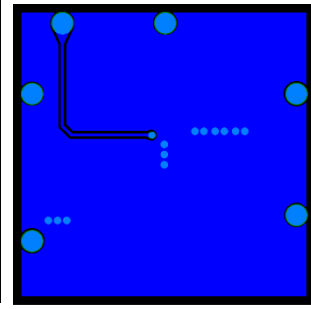

USP-6C

Layer 1

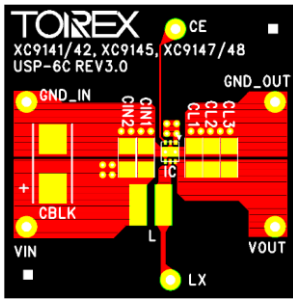

Layer 2

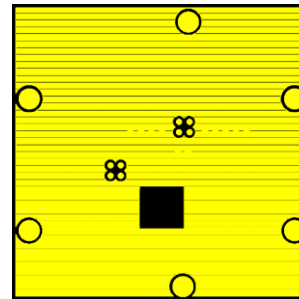

Layer 3

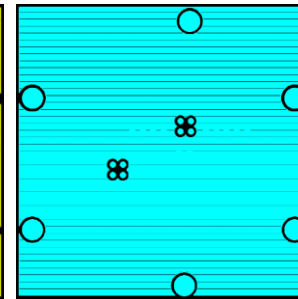

Layer 4

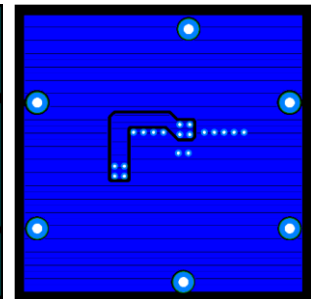

WLP-6-01

Layer 1

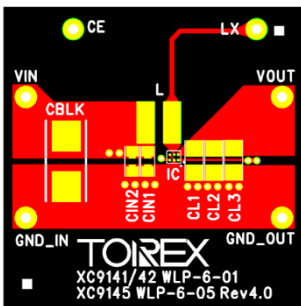

Layer 2

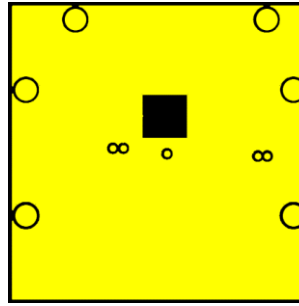

Layer 3

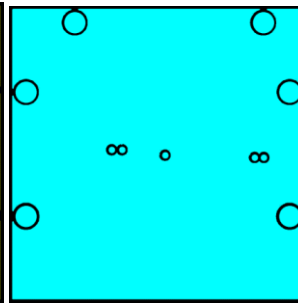

Layer 4

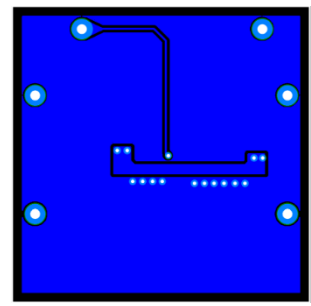

TYPICAL PERFORMANCE CHARACTERISTICS

(1) Efficiency vs. Output Current

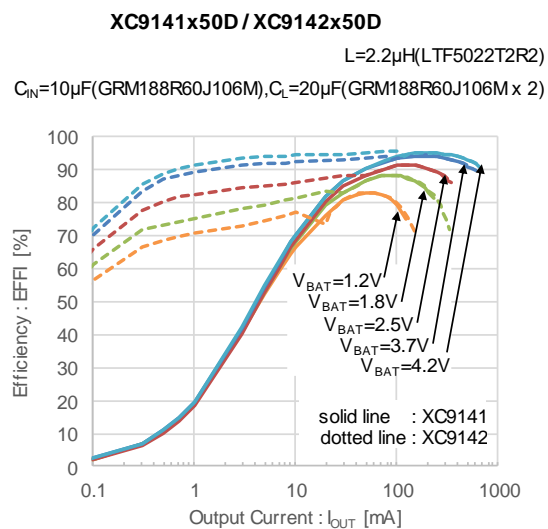
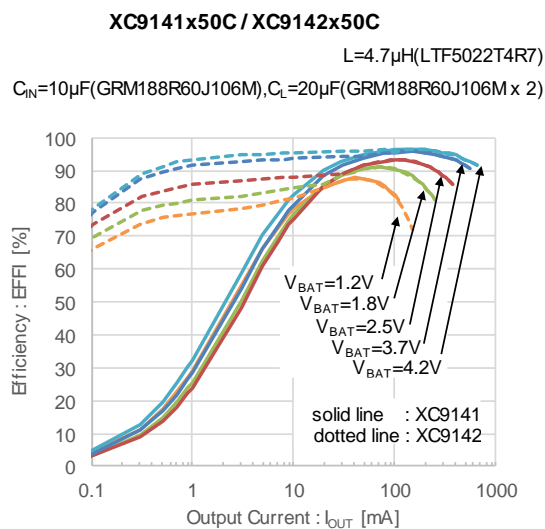
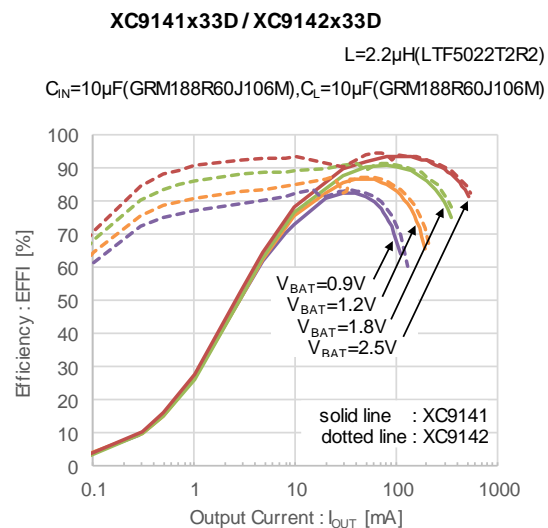
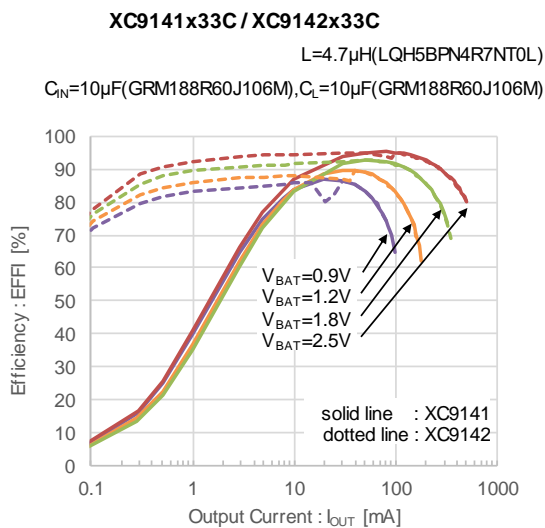
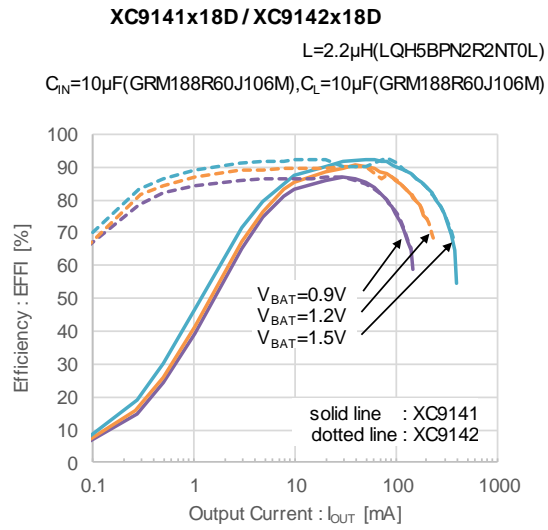
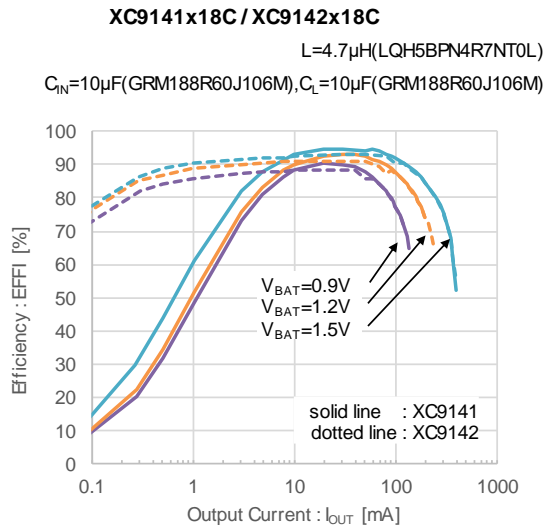

TYPICAL PERFORMANCE CHARACTERISTICS (Continued)

(2) Output Voltage vs. Output Current

XC9141x18C / XC9142x18C

L=4.7μH(LQH5BPN4R7NT0L)

C_{IN}=10μF(GRM188R60J106M), C_L=10μF(GRM188R60J106M)

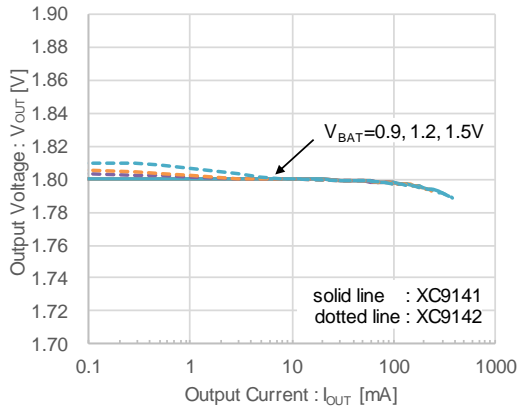

XC9141x18D / XC9142x18D

L=2.2μH(LQH5BPN2R2NT0L)

C_{IN}=10μF(GRM188R60J106M), C_L=10μF(GRM188R60J106M)

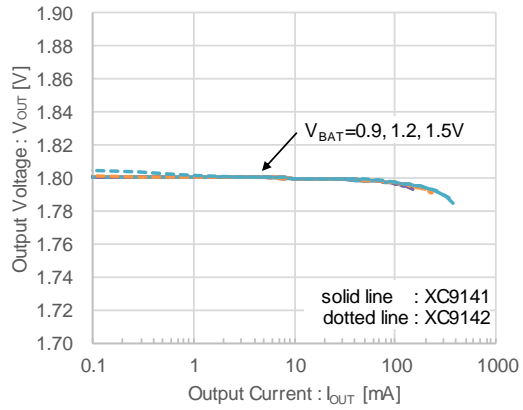

XC9141x33C / XC9142x33C

L=4.7μH(LQH5BPN4R7NT0L)

C_{IN}=10μF(GRM188R60J106M), C_L=10μF(GRM188R60J106M)

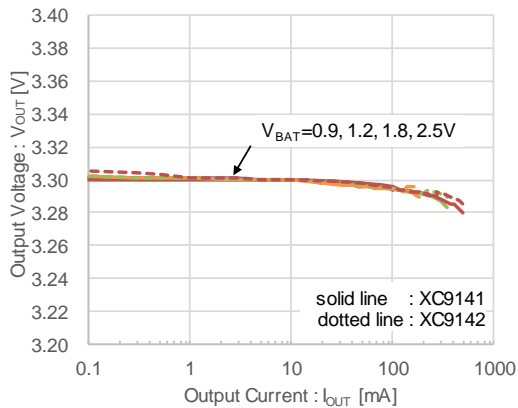

XC9141x33D / XC9142x33D

L=2.2μH(LTF5022T2R2)

C_{IN}=10μF(GRM188R60J106M), C_L=10μF(GRM188R60J106M)

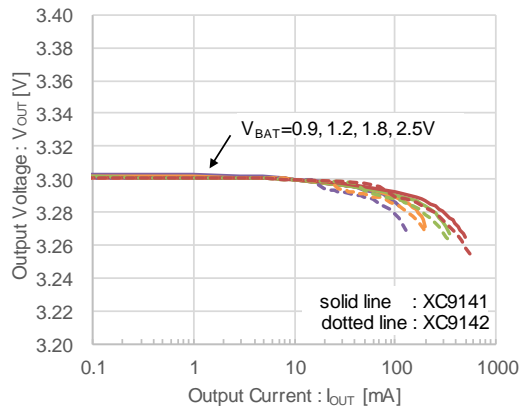

XC9141x50C / XC9142x50C

L=4.7μH(LTF5022T4R7)

C_{IN}=10μF(GRM188R60J106M), C_L=20μF(GRM188R60J106M x 2)

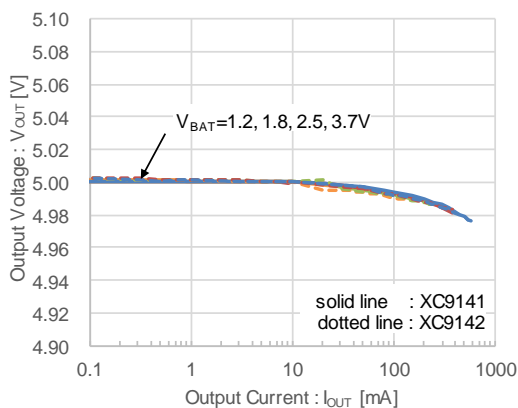

XC9141x50D / XC9142x50D

L=2.2μH(LTF5022T2R2)

C_{IN}=10μF(GRM188R60J106M), C_L=20μF(GRM188R60J106M x 2)

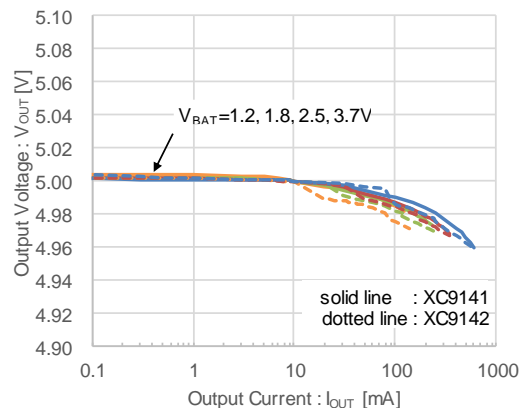

TYPICAL PERFORMANCE CHARACTERISTICS (Continued)

(3) Ripple Voltage vs. Output Current

XC9141x18C / XC9142x18C

L=4.7μH(LQH5BPN4R7NT0L)

C_{IN}=10μF(GRM188R60J106M), C_L=10μF(GRM188R60J106M)

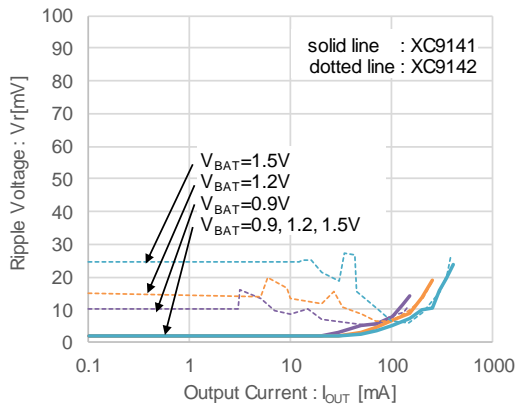

XC9141x18D / XC9142x18D

L=2.2μH(LQH5BPN2R2NT0L)

C_{IN}=10μF(GRM188R60J106M), C_L=10μF(GRM188R60J106M)

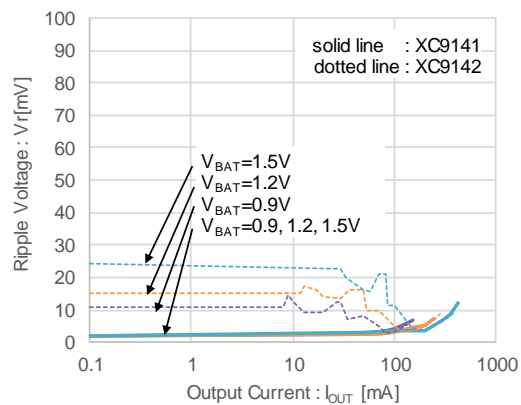

XC9141x33C / XC9142x33C

L=4.7μH(LQH5BPN4R7NT0L)

C_{IN}=10μF(GRM188R60J106M), C_L=10μF(GRM188R60J106M)

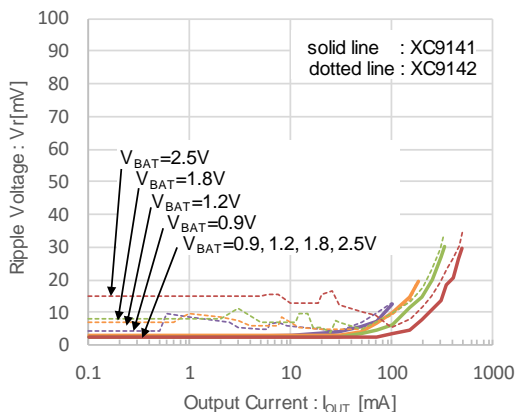

XC9141x33D / XC9142x33D

L=2.2μH(LTF5022T2R2)

C_{IN}=10μF(GRM188R60J106M), C_L=10μF(GRM188R60J106M)

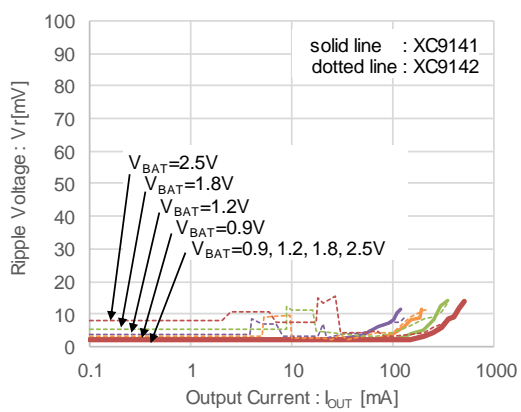

XC9141x50C / XC9142x50C

L=4.7μH(LTF5022T4R7)

C_{IN}=10μF(GRM188R60J106M), C_L=20μF(GRM188R60J106M x 2)

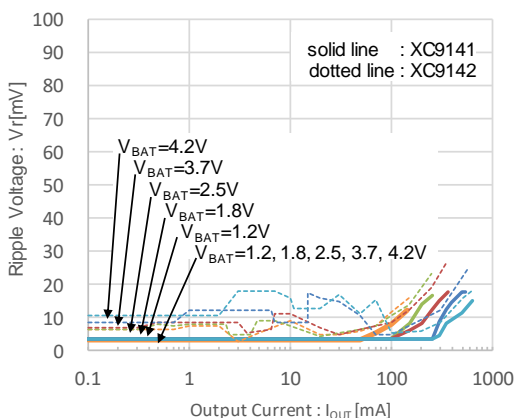

XC9141x50D / XC9142x50D

L=2.2μH(LTF5022T2R2)

C_{IN}=10μF(GRM188R60J106M), C_L=20μF(GRM188R60J106M x 2)

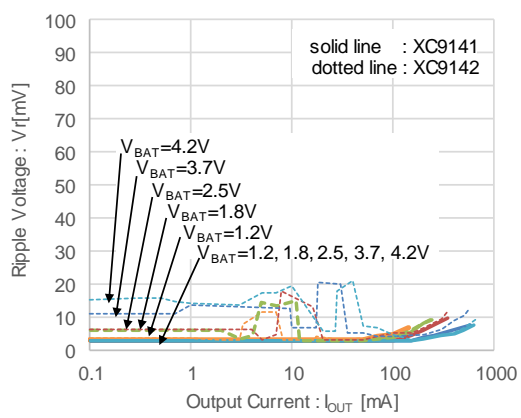

TYPICAL PERFORMANCE CHARACTERISTICS (Continued)

(4) Output Voltage vs. Ambient Temperature

XC9141x18C/XC9142x18C

L=4.7μH(LQH5BPN4R7NT0L)

C_{IN}=10μF(GRM188R60J106M), C_L=10μF(GRM188R60J106M)

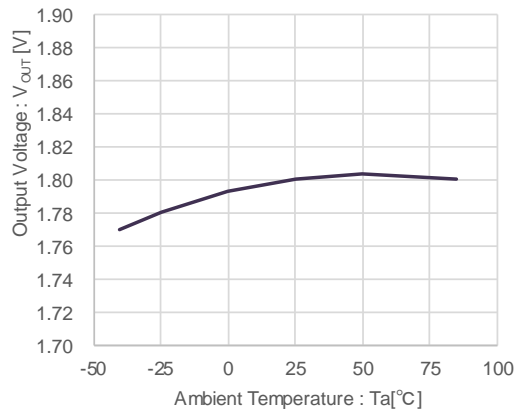

XC9141x33C/XC9142x33C

L=4.7μH(LQH5BPN4R7NT0L)

C_{IN}=10μF(GRM188R60J106M), C_L=10μF(GRM188R60J106M)

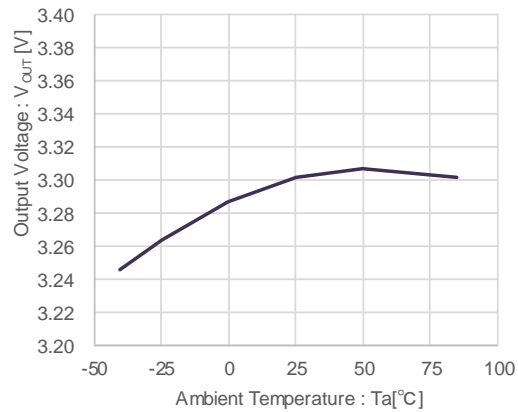

(5) Quiescent Current vs. Output Voltage

XC9142x18C

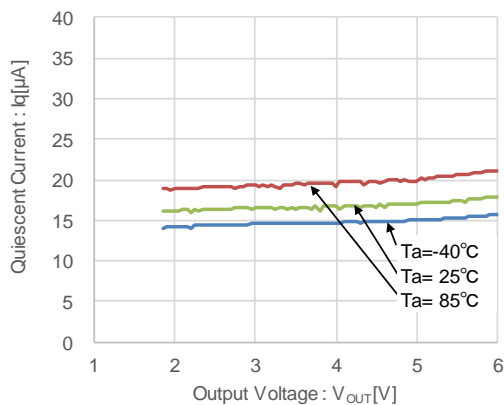

XC9142x18D

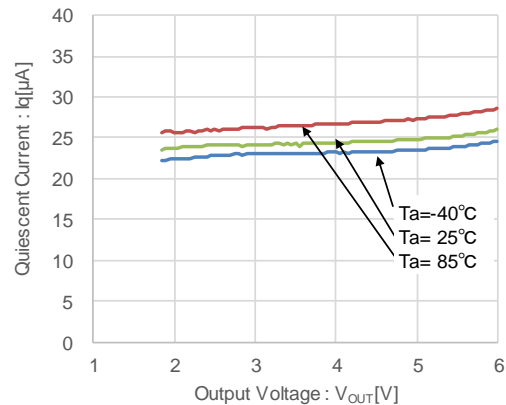

(6) Supply Current vs. Output voltage

XC9141x50C / XC9142x50C

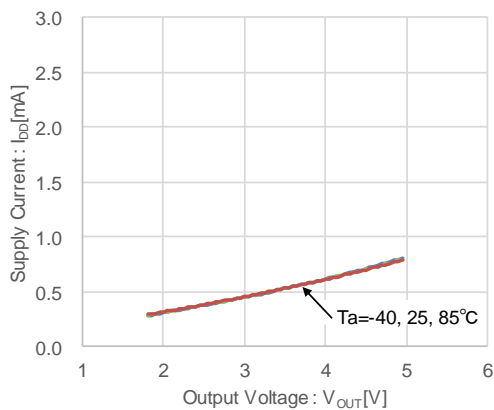

XC9141x50D / XC9142x50D

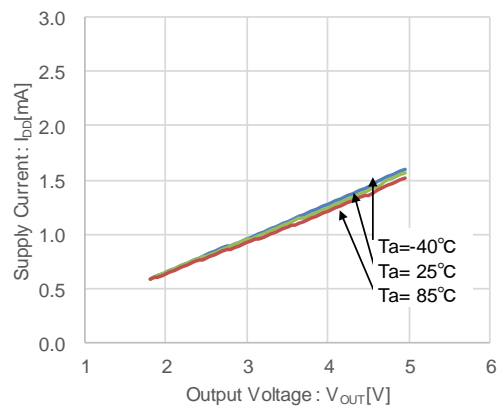

■ TYPICAL PERFORMANCE CHARACTERISTICS (Continued)

(7) Stand-by Current vs. Ambient Temperature

XC9141A / XC9142A
XC9141B / XC9142B
XC9141D / XC9142D
XC9141E / XC9142E

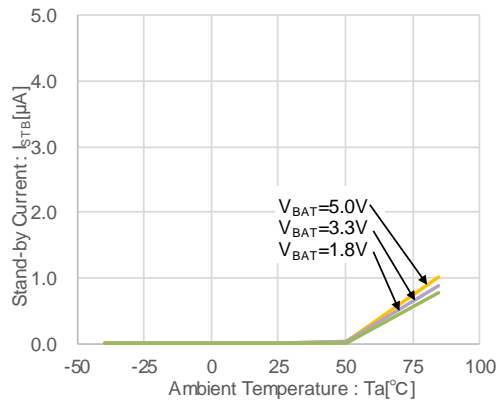

XC9142C / XC9142F

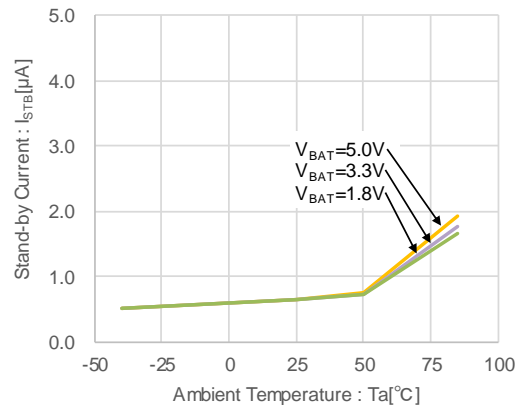

(8) C_L Discharge Resistance vs. Ambient Temperature

XC9141A / XC9142A
XC9141D / XC9142D

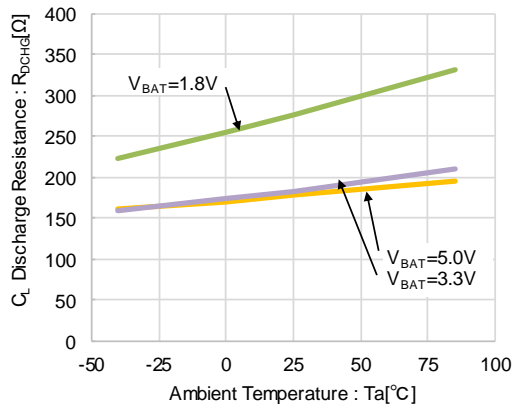

(9) Bypass SW Resistance vs. Ambient Temperature

XC9141B / XC9142B
XC9141E / XC9142E

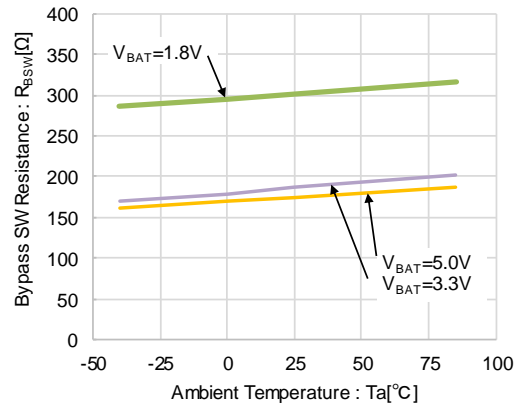

(10) Lx SW "Pch" ON Resistance vs. Ambient Temperature

XC9141 / XC9142

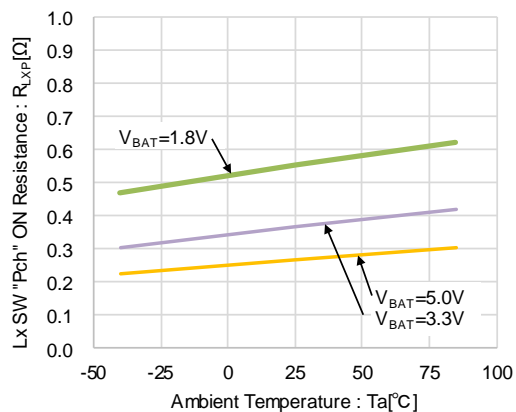

(11) Lx SW "Nch" ON Resistance vs. Output Voltage

XC9141 / XC9142

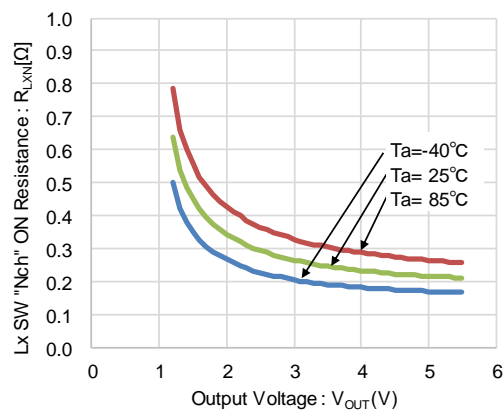

TYPICAL PERFORMANCE CHARACTERISTICS (Continued)

(12) CE "H" Voltage vs. Ambient Temperature

XC9141 / XC9142

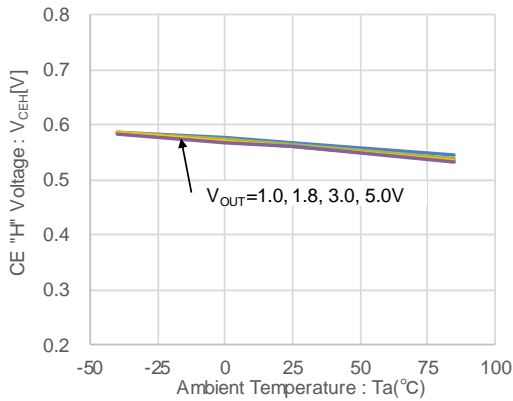

(13) CE "L" Voltage vs. Ambient Temperature

XC9141 / XC9142

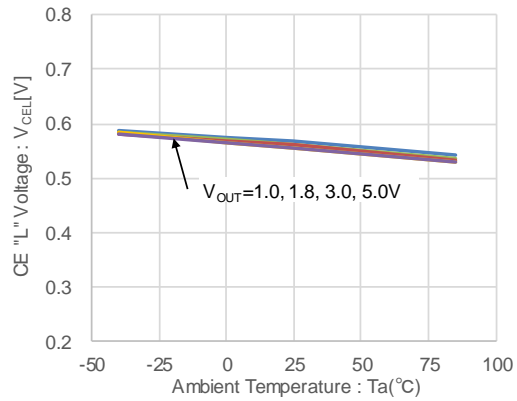

(14) Lx SW "H" Leakage Current vs. Ambient temperature

XC9141A / XC9142A
XC9141B / XC9142B
XC9141D / XC9142D
XC9141E / XC9142E

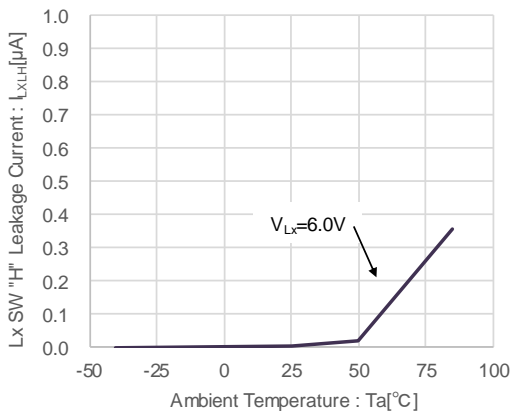

(15) Lx SW "L" Leakage Current vs. Ambient temperature

XC9142C / XC9142F

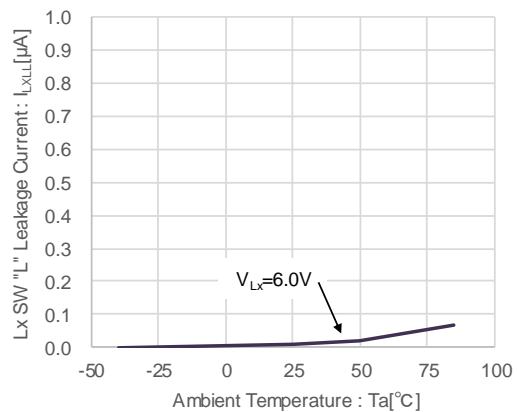

(16) Oscillation Frequency vs. Ambient temperature

XC9141xxxC / XC9142xxxC

L=4.7µH(LQH5BPN4R7NT0L)
C_{IN}=10µF(GRM188R60J106M), C_L=10µF(GRM188R60J106M)

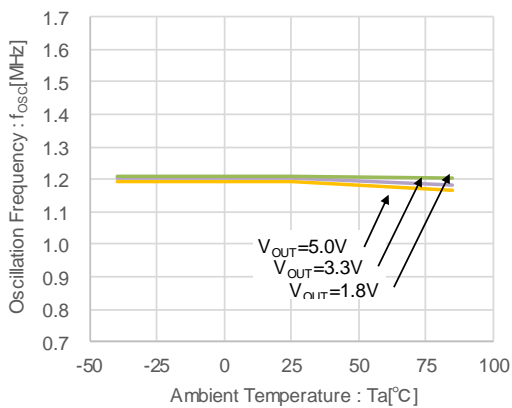

XC9141xxxD / XC9142xxxD

L=2.2µH(LQH5BPN2R2NT0L)
C_{IN}=10µF(GRM188R60J106M), C_L=10µF(GRM188R60J106M)

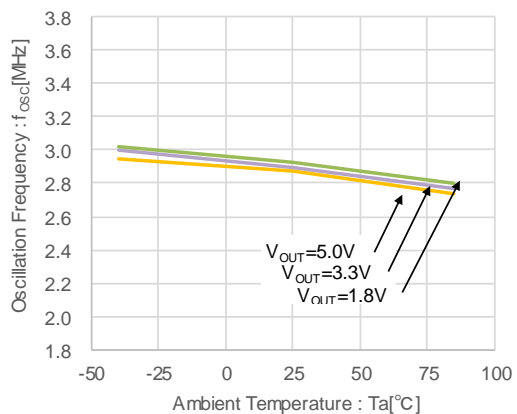

TYPICAL PERFORMANCE CHARACTERISTICS (Continued)

(17) Maximum Duty Cycle vs. Ambient temperature

XC9141xxxC / XC9142xxxC

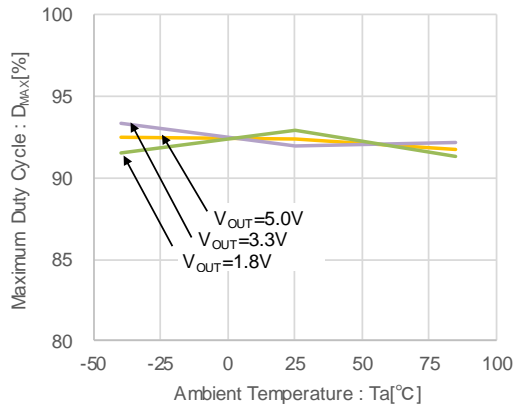

XC9141xxxD / XC9142xxxD

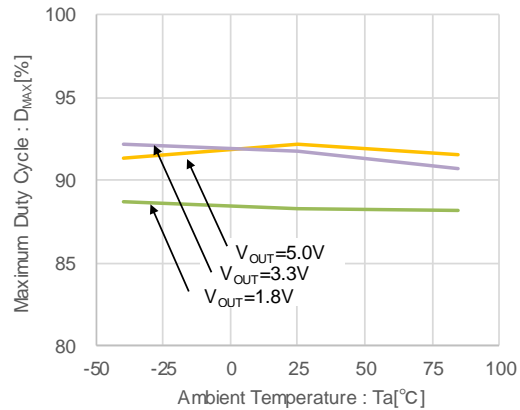

(18) Soft-Start Time vs. Ambient temperature

XC9141xxxC / XC9142xxxC

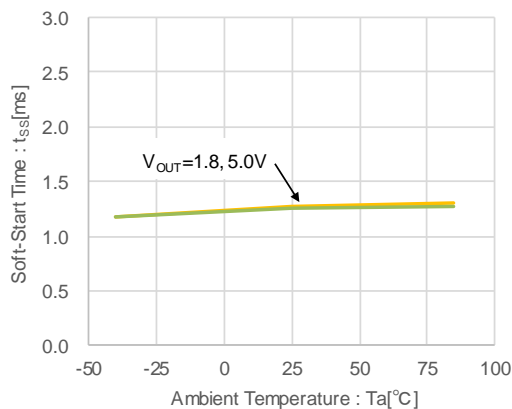

XC9141xxxD / XC9142xxxD

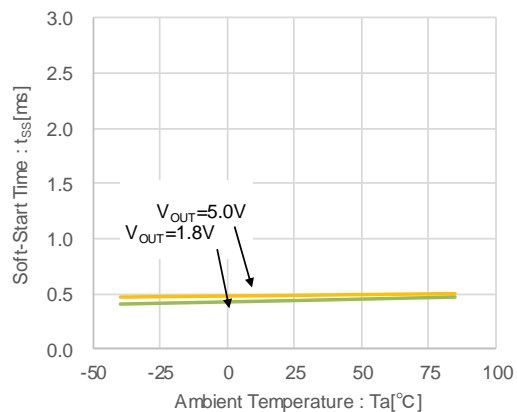

(19) PFM Switching Current vs. Input Voltage

XC9142x50C

$L=4.7\mu\text{H}$ (LQH5BPN4R7NT0L)

$C_{IN}=10\mu\text{F}$ (GRM188R60J106M), $C_L=10\mu\text{F}$ (GRM188R60J106M)

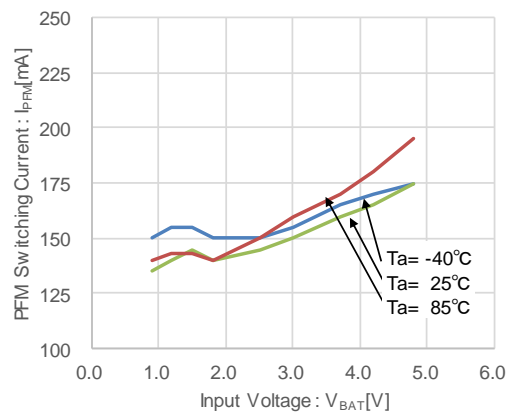

XC9142x50D

$L=2.2\mu\text{H}$ (LQH5BPN2R2NT0L)

$C_{IN}=10\mu\text{F}$ (GRM188R60J106M), $C_L=10\mu\text{F}$ (GRM188R60J106M)

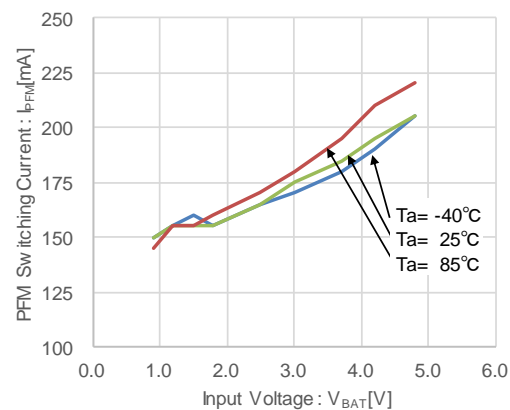

TYPICAL PERFORMANCE CHARACTERISTICS (Continued)

(20) Operation Start Voltage vs. Ambient temperature

XC9141 / XC9142

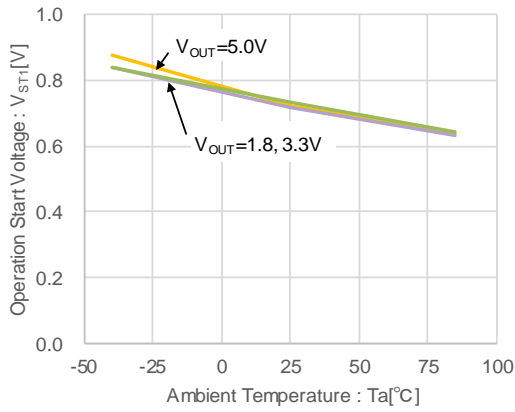

(21) Operation Hold Voltage vs. Ambient temperature

XC9141 / XC9142

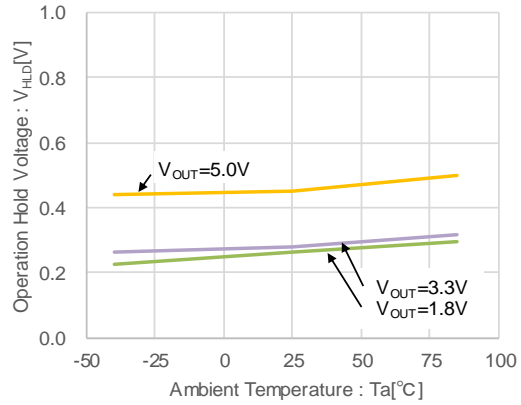

(22) Current Limit vs. Ambient temperature

XC9141xxxC / XC9142xxxC

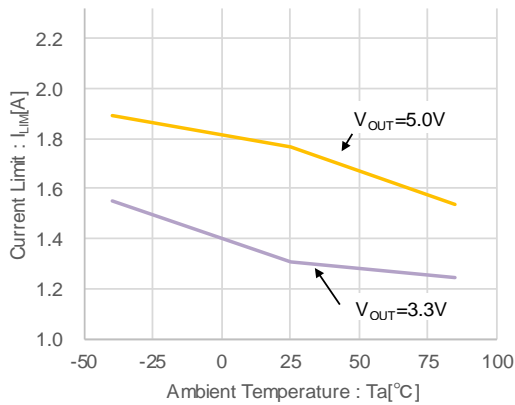

XC9141xxxD / XC9142xxxD

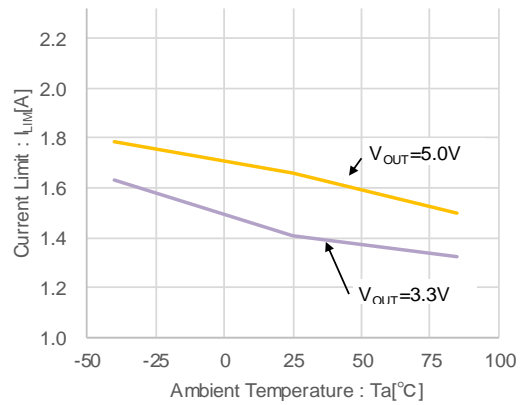

TYPICAL PERFORMANCE CHARACTERISTICS (Continued)

(23) Integral Latch Time vs. Ambient temperature

XC9141DxxC / XC9142DxxC
XC9141ExxC / XC9142ExxC
XC9142FxxC

L=4.7μH(LTF5022T4R7)

C_{IN}=10μF(GRM188R60J106M),C_L=10μF(GRM188R60J106M)

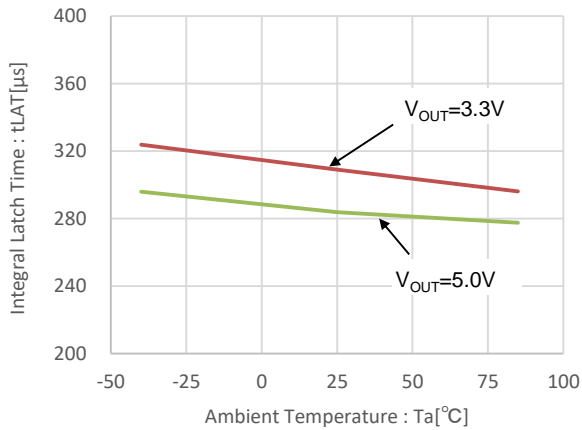

XC9141DxxC / XC9142DxxC
XC9141ExxC / XC9142ExxC
XC9142FxxC

L=4.7μH(LTF5022T4R7)

C_{IN}=10μF(GRM188R60J106M),C_L=10μF(GRM188R60J106M)

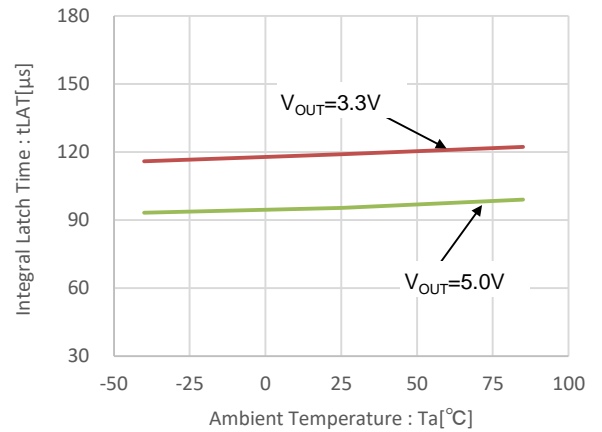

(24) Latch Release Voltage vs. Ambient temperature

XC9141D / XC9142D
XC9141E / XC9142E
XC9142F

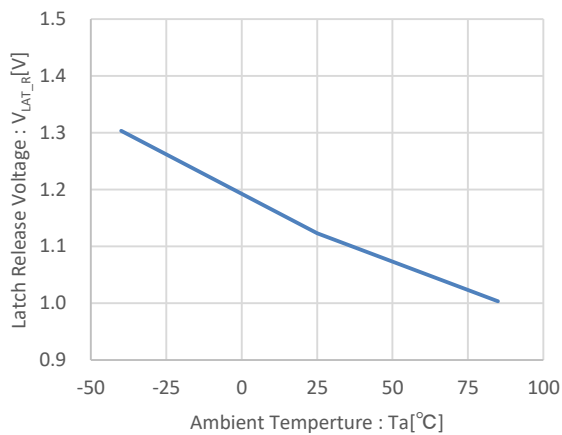

TYPICAL PERFORMANCE CHARACTERISTICS (Continued)

(25) Load Transient Response

XC9141x18C

$V_{BAT}=1.2V, V_{OUT}=1.8V, I_{OUT}=10mA \leftrightarrow 100mA$
 $L=4.7\mu H(LTF5022T4R7)$

$C_{IN}=10\mu F(GRM188R60J106M), C_L=10\mu F(GRM188R60J106M)$

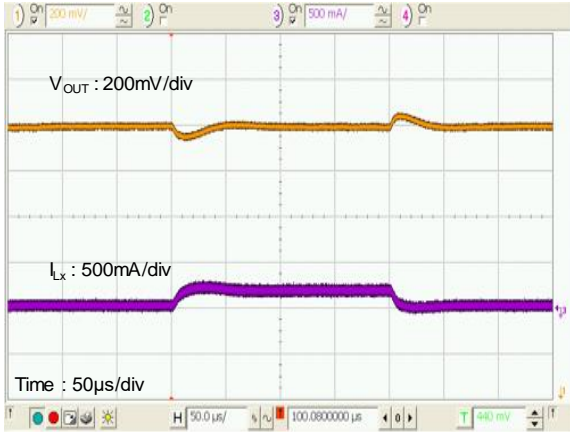

XC9142x18C

$V_{BAT}=1.2V, V_{OUT}=1.8V, I_{OUT}=10mA \leftrightarrow 100mA$
 $L=4.7\mu H(LTF5022T4R7)$

$C_{IN}=10\mu F(GRM188R60J106M), C_L=10\mu F(GRM188R60J106M)$

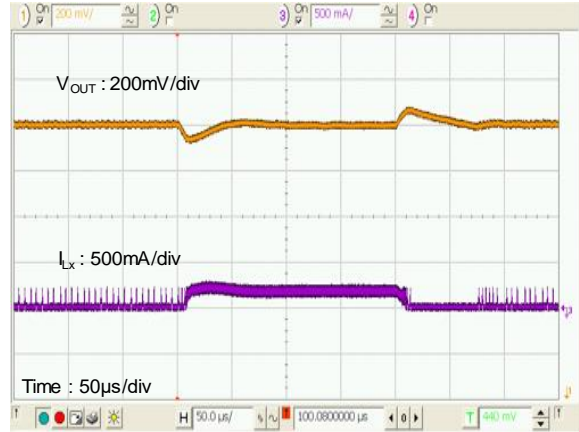

XC9141x33C

$V_{BAT}=2.4V, V_{OUT}=3.3V, I_{OUT}=20mA \leftrightarrow 300mA$
 $L=4.7\mu H(LTF5022T4R7)$

$C_{IN}=10\mu F(GRM188R60J106M), C_L=10\mu F(GRM188R60J106M)$



XC9142x33C

$V_{BAT}=2.4V, V_{OUT}=3.3V, I_{OUT}=20mA \leftrightarrow 300mA$
 $L=4.7\mu H(LTF5022T4R7)$

$C_{IN}=10\mu F(GRM188R60J106M), C_L=10\mu F(GRM188R60J106M)$



XC9141x50C

$V_{BAT}=3.7V, V_{OUT}=5.0V, I_{OUT}=20mA \leftrightarrow 300mA$
 $L=4.7\mu H(LTF5022T4R7)$

$C_{IN}=10\mu F(GRM188R60J106M), C_L=20\mu F(GRM188R60J106M \times 2)$



XC9142x50C

$V_{BAT}=3.7V, V_{OUT}=5.0V, I_{OUT}=20mA \leftrightarrow 300mA$
 $L=4.7\mu H(LTF5022T4R7)$

$C_{IN}=10\mu F(GRM188R60J106M), C_L=20\mu F(GRM188R60J106M \times 2)$



■ TYPICAL PERFORMANCE CHARACTERISTICS (Continued)

(25) Load Transient Response

XC9141x18D

$V_{BAT}=1.2V, V_{OUT}=1.8V, I_{OUT}=10mA \leftrightarrow 100mA$
 $L=2.2\mu H(LTF5022T2R2)$

$C_{IN}=10\mu F(GRM188R60J106M), C_L=10\mu F(GRM188R60J106M)$

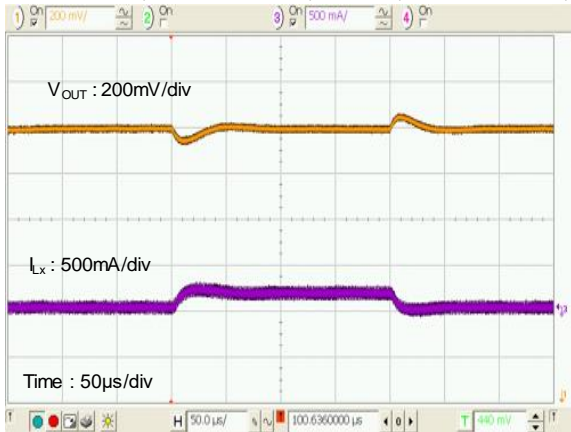

XC9142x18D

$V_{BAT}=1.2V, V_{OUT}=1.8V, I_{OUT}=10mA \leftrightarrow 100mA$
 $L=2.2\mu H(LTF5022T2R2)$

$C_{IN}=10\mu F(GRM188R60J106M), C_L=10\mu F(GRM188R60J106M)$



XC9141x33D

$V_{BAT}=2.4V, V_{OUT}=3.3V, I_{OUT}=20mA \leftrightarrow 300mA$
 $L=2.2\mu H(LTF5022T2R2)$

$C_{IN}=10\mu F(GRM188R60J106M), C_L=10\mu F(GRM188R60J106M)$

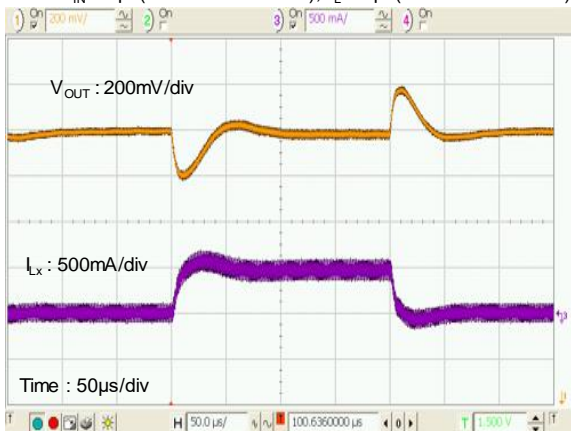

XC9142x33D

$V_{BAT}=2.4V, V_{OUT}=3.3V, I_{OUT}=20mA \leftrightarrow 300mA$
 $L=2.2\mu H(LTF5022T2R2)$

$C_{IN}=10\mu F(GRM188R60J106M), C_L=10\mu F(GRM188R60J106M)$

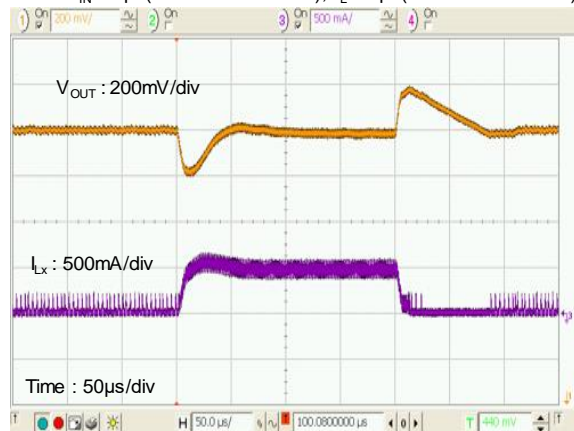

XC9141x50D

$V_{BAT}=3.7V, V_{OUT}=5.0V, I_{OUT}=20mA \leftrightarrow 300mA$
 $L=2.2\mu H(LTF5022T2R2)$

$C_{IN}=10\mu F(GRM188R60J106M), C_L=20\mu F(GRM188R60J106M \times 2)$

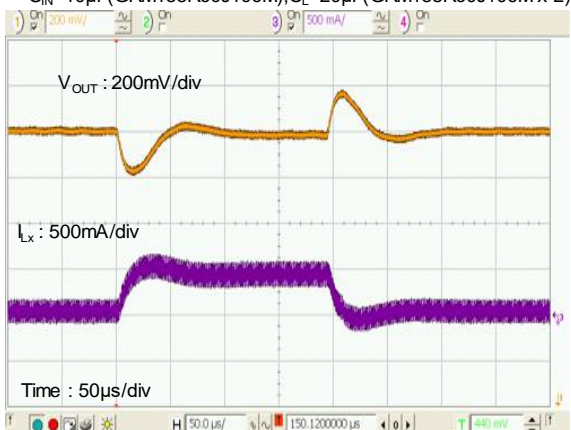

XC9142x50D

$V_{BAT}=3.7V, V_{OUT}=5.0V, I_{OUT}=20mA \leftrightarrow 300mA$
 $L=2.2\mu H(LTF5022T2R2)$

$C_{IN}=10\mu F(GRM188R60J106M), C_L=20\mu F(GRM188R60J106M \times 2)$

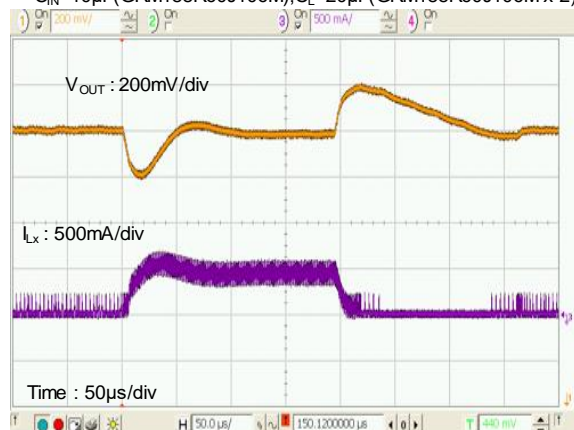

■ PACKAGING INFORMATION

For the latest package information go to, www.torexsemi.com/technical-support/packages

PACKAGE	OUTLINE / LAND PATTERN	THERMAL CHARACTERISTICS
SOT-25	SOT-25 PKG	SOT-25 Power Dissipation
USP-6C	USP-6C PKG	USP-6C Power Dissipation
WLP-6-01	WLP-6-01 PKG	WLP-6-01 Power Dissipation

MARKING RULE

SOT-25 (Under dot)

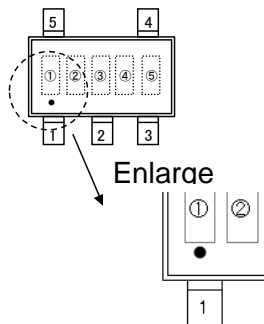

USP-6C

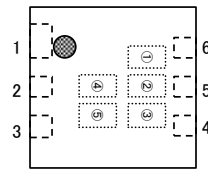

WLP-6-01

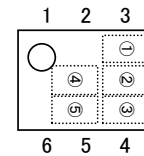

① represents products series

MARK	PRODUCT SERIES
Y	XC9141/42A/B/C/D/Sxxxx-G
Z	XC9141/42E/Fxxxx-G

② represents products series, Oscillation Frequency, and output voltage range

SERIES	OSCILLATION FREQUENCY	OUTPUT VOLTAGE RANGE [V]		PRODUCT SERIES
		1.8~3.7	3.8~5.5	
XC9141A	1.2MHz	0	1	XC9141AxxCxx-G
XC9141B		2	3	XC9141BxxCxx-G
XC9141D		8	9	XC9141DxxCxx-G
XC9141E		A	B	XC9141ExxCxx-G
XC9141A	3.0MHz	4	5	XC9141AxxDxx-G
XC9141B		6	7	XC9141BxxDxx-G
XC9141D		R	U	XC9141DxxDxx-G
XC9141E		C	D	XC9141ExxDxx-G
XC9142A	1.2MHz	A	B	XC9142AxxCxx-G
XC9142B		C	D	XC9142BxxCxx-G
XC9142C		E	F	XC9142CxxCxx-G
XC9142D		V	X	XC9142DxxCxx-G
XC9142E		E	F	XC9142ExxCxx-G
XC9142F		H	K	XC9142FxxCxx-G
XC9142A	3.0MHz	H	K	XC9142AxxDxx-G
XC9142B		L	M	XC9142BxxDxx-G
XC9142C		N	P	XC9142CxxDxx-G
XC9142D		Y	Z	XC9142DxxDxx-G
XC9142E		L	M	XC9142ExxDxx-G
XC9142F		N	P	XC9142FxxDxx-G

③ represents output voltage

MARK	OUTPUT VOLTAGE [V]		MARK	OUTPUT VOLTAGE [V]	
0	1.8	3.8	A	2.8	4.8
1	1.9	3.9	B	2.9	4.9
2	2.0	4.0	C	3.0	5.0
3	2.1	4.1	D	3.1	5.1
4	2.2	4.2	E	3.2	5.2
5	2.3	4.3	F	3.3	5.3
6	2.4	4.4	H	3.4	5.4
7	2.5	4.5	K	3.5	5.5
8	2.6	4.6	L	3.6	-
9	2.7	4.7	M	3.7	-

④,⑤ represents production lot number

01~09, 0A~0Z, 11~9Z, A1~A9, AA~AZ, B1~ZZ in order.

(G, I, J, O, Q, W excluded)

* No character inversion used.

1. The product and product specifications contained herein are subject to change without notice to improve performance characteristics. Consult us, or our representatives before use, to confirm that the information in this datasheet is up to date.
2. The information in this datasheet is intended to illustrate the operation and characteristics of our products. We neither make warranties or representations with respect to the accuracy or completeness of the information contained in this datasheet nor grant any license to any intellectual property rights of ours or any third party concerning with the information in this datasheet.
3. Applicable export control laws and regulations should be complied and the procedures required by such laws and regulations should also be followed, when the product or any information contained in this datasheet is exported.
4. The product is neither intended nor warranted for use in equipment of systems which require extremely high levels of quality and/or reliability and/or a malfunction or failure which may cause loss of human life, bodily injury, serious property damage including but not limited to devices or equipment used in 1) nuclear facilities, 2) aerospace industry, 3) medical facilities, 4) automobile industry and other transportation industry and 5) safety devices and safety equipment to control combustions and explosions. Do not use the product for the above use unless agreed by us in writing in advance.
5. Although we make continuous efforts to improve the quality and reliability of our products; nevertheless Semiconductors are likely to fail with a certain probability. So in order to prevent personal injury and/or property damage resulting from such failure, customers are required to incorporate adequate safety measures in their designs, such as system fail safes, redundancy and fire prevention features.
6. Our products are not designed to be Radiation-resistant.
7. Please use the product listed in this datasheet within the specified ranges.
8. We assume no responsibility for damage or loss due to abnormal use.
9. All rights reserved. No part of this datasheet may be copied or reproduced unless agreed by Torex Semiconductor Ltd in writing in advance.

TOREX SEMICONDUCTOR LTD.