

800mA 1 Cell Li-ion and Li-Po Battery Linear Charger IC with Constant-Current/Constant-Voltage

■ GENERAL DESCRIPTION

The XC6802 series is a constant-current/constant-voltage linear charger IC for single cell Lithium-ion and Lithium polymer batteries. The XC6802 includes a reference voltage source, battery voltage monitor, driver transistor, constant-current/constant-voltage charge circuit, overheat protection circuit and phase compensation circuit. The battery charge termination voltage is internally set to $4.2V \pm 0.7\%$ and the trickle charge voltage and accuracy is $2.9V \pm 3\%$. In trickle charge mode, a safe Lithium-ion and Lithium polymer battery charge is possible because approximately only 1/10 of the full charge current is supplied to the battery.

With an external R_{SEN} resistor, the charge current can be set freely up to 800mA (MAX.), therefore, the series is ideal for various battery charge applications. The series' charge status output pin, /CHG pin, is capable of checking the IC's charging state while connecting with an external LED.

■ APPLICATIONS

- Charging docks, charging cradles
- MP3 players, portable audio players
- Cellular phones, PDAs
- Bluetooth headsets

■ FEATURES

Operating Voltage Range	: 4.25V ~ 6.0V
Charge Current	: Externally set up to 800mA (MAX.)
Charge Termination Voltage	: $4.2V \pm 0.7\%$
Trickle Charge Voltage	: $2.9V \pm 3\%$
Supply Current (Stand-by)	: $15\mu A$ (TYP.)
Function	: Constant-current/constant-voltage Operation Thermal Shutdown Automatic Recharge Charge Status Output Pin Soft-start Function (Inrush Limit Current)
Operating Ambient Temperature	: $-40^{\circ}C \sim 85^{\circ}C$
Packages	: SOT-89-5, SOT-25, USP-6C, USP-6EL
Environmentally Friendly	: EU RoHS Compliant, Pb Free

■ TYPICAL APPLICATION CIRCUIT

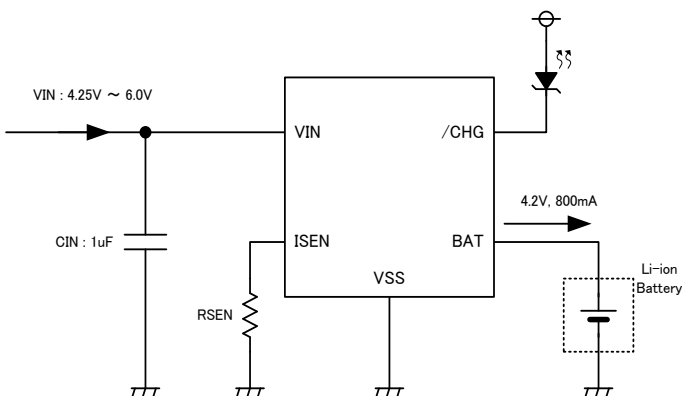

■ TYPICAL PERFORMANCE CHARACTERISTICS

● Battery Charge Cycle

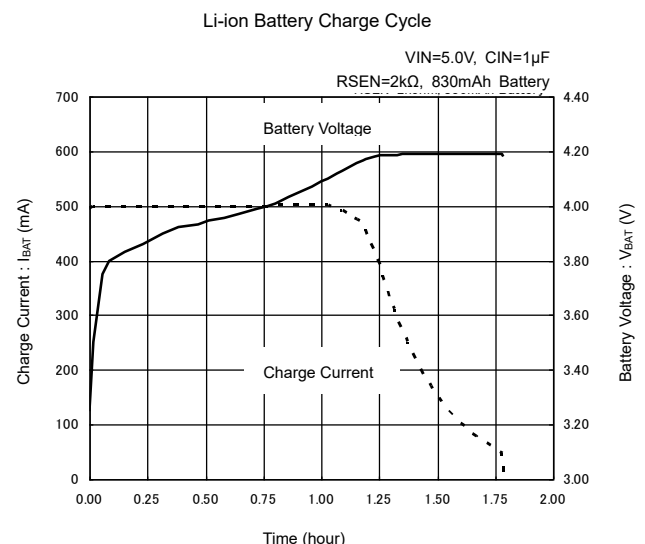

PIN CONFIGURATION

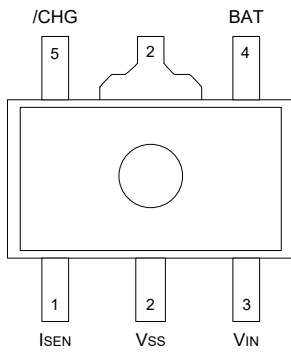

SOT-89-5
(TOP VIEW)

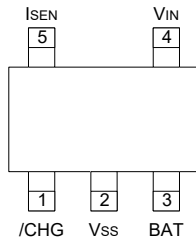

SOT-25
(TOP VIEW)

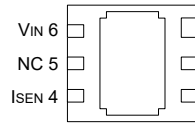

USP-6C
(BOTTOM VIEW)

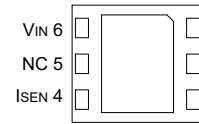

USP-6EL
(BOTTOM VIEW)

* The dissipation pad for the USP-6C / USP-6EL package should be solder-plated in recommended mount pattern and metal masking so as to enhance mounting strength and heat release. If the pad needs to be connected to other pins, it should be connected to the V_{SS} (No. 2) pin.

PIN ASSIGNMENT

PIN NUMBER				PIN NAME	FUNCTIONS
SOT-25	SOT-89-5	USP-6C	USP-6EL		
1	5	3	3	/CHG	Charge Status Output Pin
2	2	2	2	V _{SS}	Ground
3	4	1	1	BAT	Charge Current Output Pin
4	3	6	6	V _{IN}	Input Voltage Pin
5	1	4	4	I _{SEN}	Charge Current Setup Pin
-	-	5	5	NC	No Connection

FUNCTIONS

PIN NAME	CONDITIONS	IC OPERATION
I _{SEN}	H Level ($1.4V \leq V_{SEN} \leq V_{IN}$) or Open	OFF (Shutdown Mode)
	Pull-down by external components	ON, Charge Current $I_{BAT} = 1000 / R_{SEN}^*$

* For SOT-25, SOT-89-5, and USP-6C, charge current should be set to become $I_{BAT} \leq 800mA$.
For USP-6EL, charge current should be set to become $I_{BAT} \leq 500mA$.

PRODUCT CLASSIFICATION

Ordering Information

XC6802A42X①②-③

DESIGNATOR	ITEM	SYMBOL	DESCRIPTION
①②-③ (*1)	Packages (Order Unit)	PR-G	SOT-89-5 (1,000pcs/Reel)
		MR-G	SOT-25 (3,000pcs/Reel)
		ER-G	USP-6C (3,000pcs/Reel)
		4R-G	USP-6EL (3,000pcs/Reel)

■ BLOCK DIAGRAM

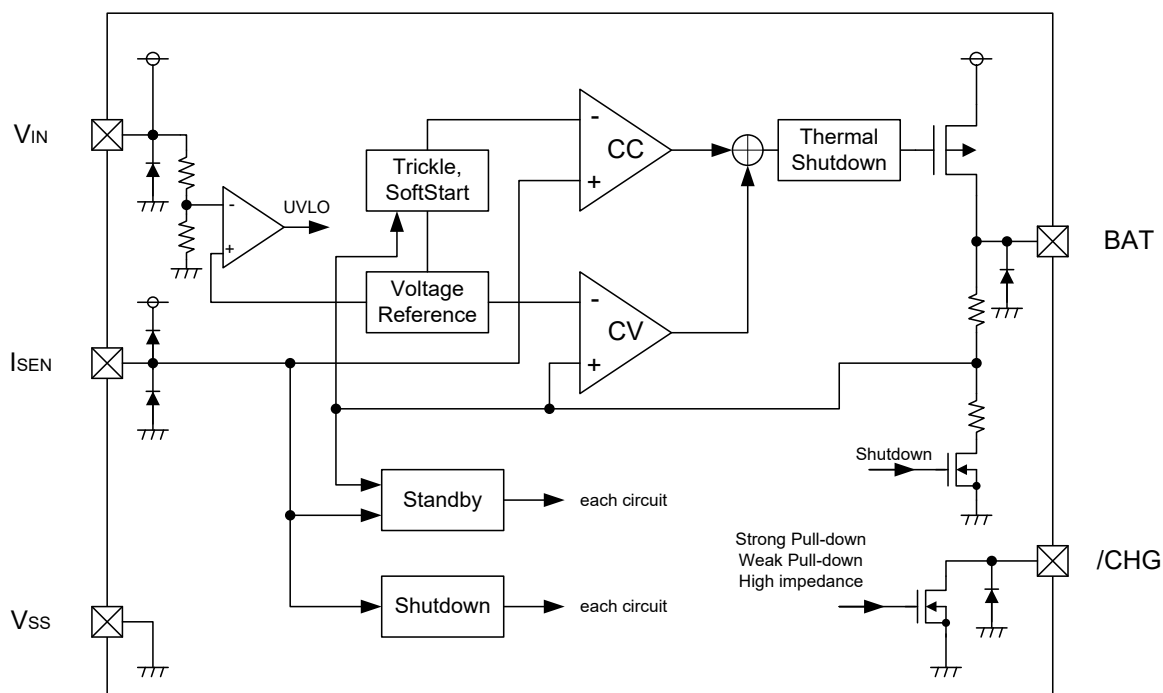

* Diodes inside the circuits are ESD protection diodes and parasitic diodes.

■ ABSOLUTE MAXIMUM RATINGS

Ta=25°C

PARAMETER	SYMBOL	RATINGS	UNIT
V _{IN} Pin Voltage	V _{IN}	-0.3 ~ 6.5	V
I _{SEN} Pin Voltage	V _{SEN}	-0.3 ~ V _{IN} + 0.3 or 6.5 ^{(*)2}	V
BAT Pin Voltage	V _{BAT}	-0.3 ~ 6.5	V
/CHG Pin Voltage	V _{/CHG}	-0.3 ~ 6.5	V
BAT Pin Current ^{(*)1}	SOT-89-5	I _{BAT}	mA
	SOT-25		
	USP-6C		
	USP-6EL		
Power Dissipation	SOT-89-5	P _d	500 (IC only)
			1300 (40mm x 40mm standard board) ^{(*)3}
	SOT-25		250 (IC only)
			600 (40mm x 40mm standard board) ^{(*)3}
	USP-6C		120 (IC only)
	USP-6EL		1000 (40mm x 40mm standard board) ^{(*)3}
Operating Ambient Temperature	T _{opr}	-40 ~ 85	°C

All voltages are described based on the V_{SS} pin.

^{(*)1} Please use within the range of I_{BAT} ≤ P_d / (V_{IN} - V_{BAT}).

^{(*)2} The maximum rating corresponds to the lowest value between V_{IN}+0.3V or 6.5V.

^{(*)3} This is a reference data taken by using the test board. Please see the power dissipation page for the mounting condition.

ELECTRICAL CHARACTERISTICS

Ta=25°C

PARAMETER	SYMBOL	CONDITIONS	MIN	TYP	MAX	UNIT	CIRCUIT
Input Voltage	V _{IN}		4.25	-	6.0	V	-
Supply Current	I _{SS}	Charge mode, R _{SEN} =10kΩ	-	15	35	μA	③
Stand-by Current	I _{STBY}	Stand-by mode	-	15	35	μA	③
Shut-down Current	I _{SHUT}	Shut-down mode (R _{SEN} =NC, V _{IN} <V _{BAT} or V _{IN} <V _{UVLO})	-	10	23	μA	③
Float Voltage 1	V _{FLOAT1}	Ta=25°C, I _{BAT} =40mA	×0.993	4.2	×1.007	V	②
Float Voltage 2 ⁽¹⁾	V _{FLOAT2}	0°C ≤ Ta ≤ 50°C, I _{BAT} =40mA	×0.99	4.2	×1.01	V	-
Maximum Battery Current ⁽²⁾	I _{BATMAX}	SOT-25 / SOT-89-5 / USP-6C	-	-	800	mA	-
		USP-6EL	-	-	500		
Battery Current 1	I _{BAT1}	R _{SEN} =10kΩ, CC mode	93	100	107	mA	③
Battery Current 2	I _{BAT2}	R _{SEN} =2kΩ, CC mode	465	500	523	mA	③
Battery Current 3	I _{BAT3}	Stand-by mode, V _{BAT} =4.2V	-	-	2	μA	③
Battery Current 4	I _{BAT4}	Shut-down mode (R _{SEN} =NC)	-	-	1	μA	⑤
Battery Current 5	I _{BAT5}	Sleep mode, V _{IN} =0V	-	-	1	μA	③
Trickle Charge Current 1	I _{TRIKL1}	V _{BAT} <V _{TRIKL} , R _{SEN} =10kΩ	6	10	14	mA	③
Trickle Charge Current 2	I _{TRIKL2}	V _{BAT} <V _{TRIKL} , R _{SEN} =2kΩ	30	50	70	mA	③
Trickle Voltage	V _{TRIKL}	R _{SEN} =10kΩ, V _{BAT} Rising	2.913	2.9	2.987	V	③
Trickle Voltage Hysteresis Width	V _{TRIKL_HYS}	-	58	90	116	mV	③
UVLO Voltage	V _{UVLO}	V _{IN} : L → H	3.686	3.8	3.914	V	③
UVLO Hysteresis Width	V _{UVLO_HYS}	-	150	190	280	mV	③
Manual Shut-down Voltage	V _{SD}	I _{SEN} : L → H	1.4	-	-	V	①
Manual Shut-down Voltage Hysteresis Width	V _{SD_HYS}	-	-	100	-	mV	①
Shut-down Release Voltage	V _{ASD}	V _{IN} : L → H	70	100	140	mV	③
V _{IN} -V _{BAT} Shut-down Release Voltage Hysteresis Width	V _{ASD_HYS}	-	-	70	-	mV	③
C/10 Charge Termination Current Threshold 1	I _{TERM1}	R _{SEN} =10kΩ	0.07	0.10	0.13	mA/mA	②
C/10 Charge Termination Current Threshold 2	I _{TERM2}	R _{SEN} =2kΩ	0.07	0.10	0.13	mA/mA	②
I _{SEN} Pin Voltage	V _{ISEN}	R _{SEN} =10kΩ, CC mode	-	1.0	-	V	③
/CHG Pin Weak Pull-down Current	I _{/CHG1}	V _{BAT} =4.3, V _{/CHG} =5V	8	20	50	μA	③
/CHG Pin Strong Pull-down Current	I _{/CHG2}	V _{BAT} =4.0V, V _{/CHG} =1V	4	10	20	mA	③
/CHG Pin Output Low Voltage	V _{/CHG}	I _{/CHG} =5mA	-	0.35	0.7	V	④
Recharge Battery Threshold Voltage	ΔV _{RECHRG}	V _{FLOAT1} -V _{RECHRG}	100	150	200	mV	③
ON Resistance	R _{ON}	I _{BAT} =100mA	-	450	900	mΩ	①
Soft-start Time	t _{SS}		100	150	200	μs	⑥
Recharge Battery Time	t _{RECHRG}		0.4	2	4	ms	②
Battery Termination Detect Time	t _{TERM}	I _{BAT} falling (less than charge current /10)	0.3	1	3.5	ms	②
I _{SEN} Pin Pull-up Current	I _{SEN_pull_up}	-	-	1.3	-	μA	①
Thermal Shut-down Detect Temperature	T _{TSD}	Junction temperature	-	115	-	°C	-
Thermal Shut-down Release Temperature	T _{TSR}	Junction temperature	-	95	-	°C	-

* Unless otherwise stated, V_{IN}=5.0V.

⁽¹⁾ The figures under the condition of 0°C ≤ Ta ≤ 50°C are guaranteed by design calculation.

⁽²⁾ The R_{SEN} resistance set: The battery current shall not be exceeded to 800mA. (SOT-25, SOT-89-5, and USP-6C)
The battery current shall not be exceeded to 500mA. (USP-6EL)

OPERATIONAL EXPLANATION

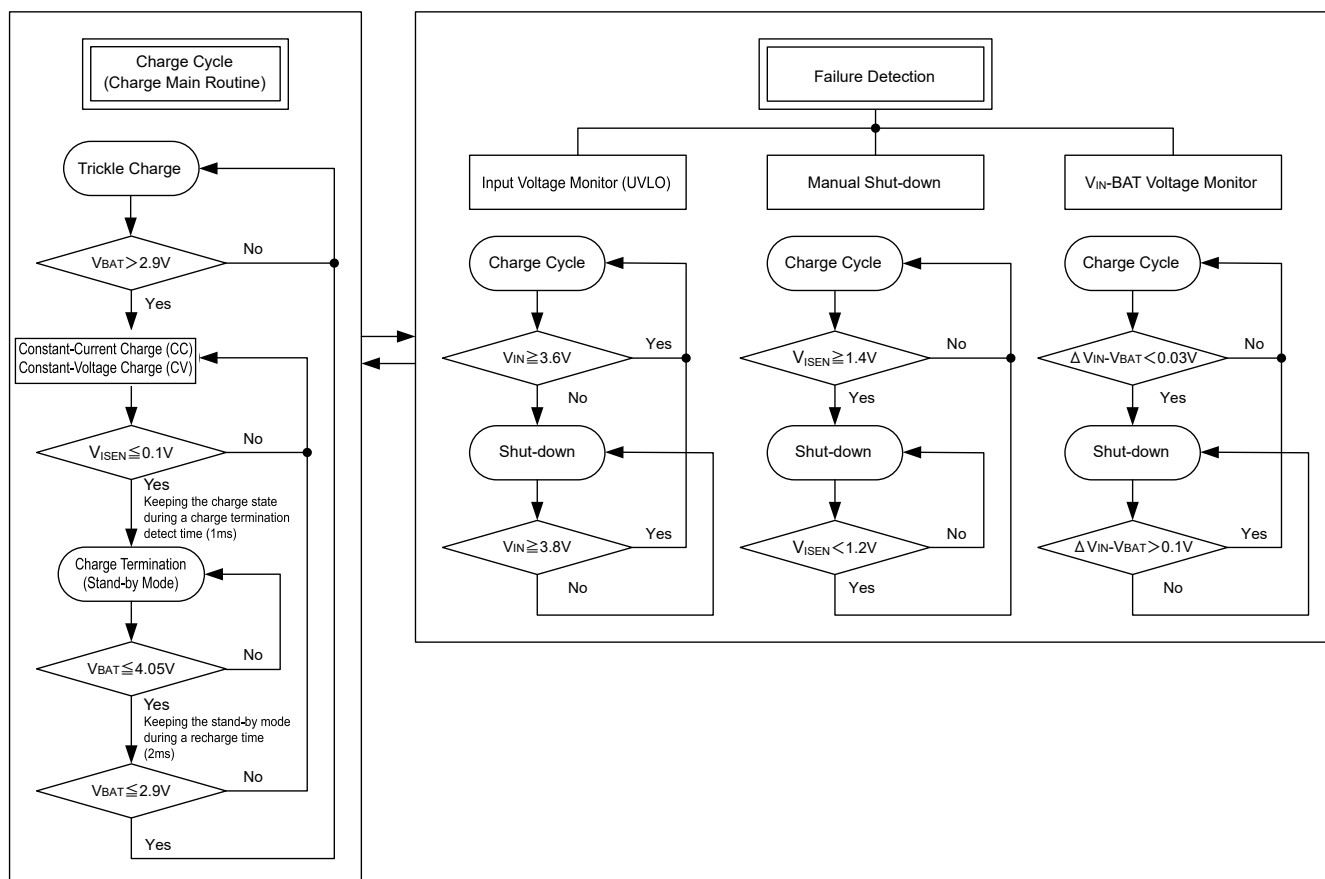

<Charge Cycle>

If the BAT pin voltage is less than trickle voltage (TYP. 2.9V), the charger enters trickle charge mode. In this mode, a safe battery charge is possible because approximately only 1/10 of the charge current which was set by the I_{SEN} pin, is supplied to the battery. When the BAT pin voltage rises above the trickle voltage, the charger enters constant-current mode (CC mode) and the battery is charged by the programmed charge current. When the BAT pin voltage reaches 4.2V, the charger enters constant-voltage mode (CV mode) automatically. After this, the charge current starts to drop and when it reaches a level which is 1/10 of the programmed charge current, the charge terminates.

<Setting Charge Current>

The charge current can be set by connecting a resistor between the I_{SEN} pin and the V_{SS} pin. The battery charge current, I_{BAT}, is 1000 times the current out of the I_{SEN} pin. Therefore, the charge current, I_{BAT}, is calculated by the following equations:

$$I_{BAT} = (V_{ISEN} / R_{SEN}) \times 1000 \quad (V_{ISEN} = 1.0V \text{ (TYP.): Current sense pin voltage})$$

However $I_{BAT} \leq 800mA$ (SOT-25, SOT-89-5, and USP-6C), $I_{BAT} \leq 500mA$ (USP-6EL)

<Charge Termination>

The battery charge is terminated when the charge current decreases to 1/10 of the full charging level after the battery pin voltage reaches a float voltage. An internal comparator monitors the I_{SEN} pin voltage to detect the charge termination. When the comparator monitors the I_{SEN} pin voltage is less than 100mV (charge termination detect) ^(*) for 1ms TYP. (charge termination detect time), the IC enters stand-by mode. A driver transistor turns off during the stand-by mode. In this state, a failure detection circuit and a monitoring circuit of the battery pin voltage operates.

(*) The detect after charging completed: I_{SEN} pin voltage should be less than 100mV.

<Automatic Recharge>

In stand-by mode battery voltage falls. When the voltage level at the battery pin drops to recharge battery threshold voltage (TYP. 4.05V) or less, the charge cycle automatically re-starts after a delay of (TYP. 2ms). As such, no external activation control is needed.

OPERATIONAL EXPLANATION (Continued)

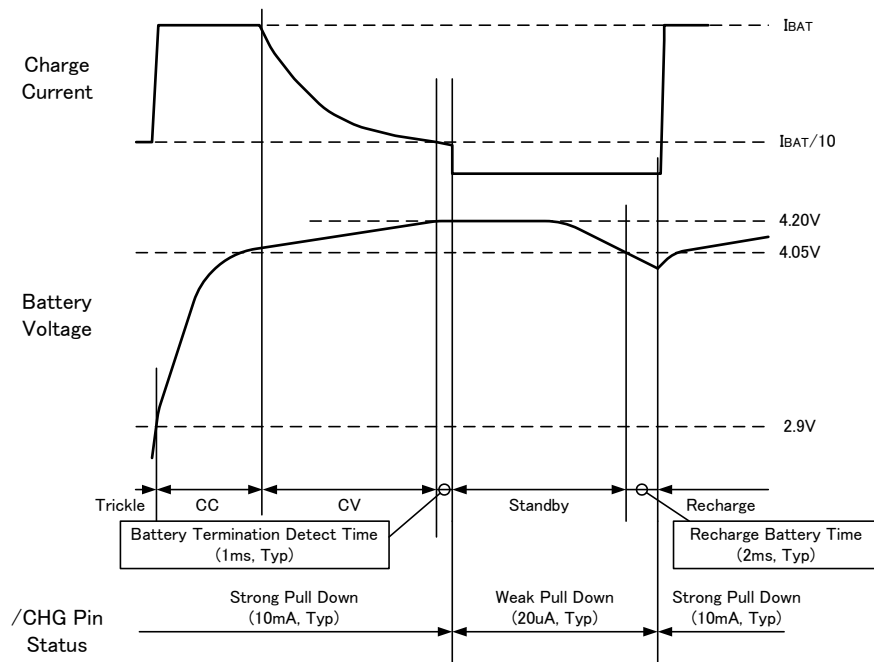

<Charge Condition Status>

The /CHG pin constantly monitors the charge states classified as below:

- Strong pull-down: $I_{\text{CHG}}=10\text{mA}$ (TYP.) in a charge cycle,
- Weak pull-down: $I_{\text{CHG}}=20\mu\text{A}$ (TYP.) in a stand-by mode,
- High impedance: in shutdown mode.

<Connection of Shorted BAT Pin>

Even if the BAT pin is shorted to the V_{SS} , a trickle charge mode starts to operate for protecting the IC from destruction caused by over current.

<Under-voltage Lockout (UVLO)>

The UVLO circuit keeps the charger in shut-down mode until the input voltage, V_{IN} , rises more than the UVLO voltage. Moreover, in order to protect the battery charger, the UVLO circuit keeps the charger in shut-down mode when a voltage between the input pin voltage and BAT pin voltage falls to less than 30mV (TYP.). The charge will not restart until the voltage between the input pin voltage and BAT pin voltage rises more than 100mV (TYP.). During the shut-down mode, the driver transistor turns off but a failure detection circuit operates, and supply current is reduced to 10 μA (TYP.).

<Soft-start Function>

To protect against inrush current from the input to the battery, soft-start time is set in the circuit optimally (150 μs , TYP.).

<Manual Shut-down>

During the charge cycle, the IC can be shifted to the shut-down mode by floating the I_{SEN} pin. For this, a drain current to the battery is reduced to less than 2 μA and a shut-down current of the IC is reduced to less than 10 μA (TYP.). A new charge cycle starts when reconnecting the current sense resistor.

<Opened BAT Pin>

When the BAT pin is left open, the IC needs to be shut-down once after monitoring the CHG pin by a microprocessor etc and keeping the I_{SEN} pin in H level.

<Backflow Prevention Between the BAT Pin and the V_{IN} Pin>

A backflow prevention circuit protects against current flowing from the BAT pin to the V_{IN} pin even the BAT pin voltage is higher than the V_{IN} pin voltage.

■ NOTES ON USE

1. Please note that in cases where the charge current is less than 100mA, there is a possibility that the trickle charge and the detection of charge completion may not function correctly.
2. For temporary, transitional voltage drop or voltage rising phenomenon, the IC is liable to malfunction should the ratings be exceeded.
3. Where wiring impedance is high, operations may become unstable due to noise and/or phase lag depending on output current. Please wire the C_{IN} as close to the IC as possible.
4. Torex places an importance on improving our products and their reliability.
We request that users incorporate fail-safe designs and post-aging protection treatment when using Torex products in their systems.

TEST CIRCUITS

1. ON Resistance, Shut-down Voltage, I_{SEN} Pull-up current

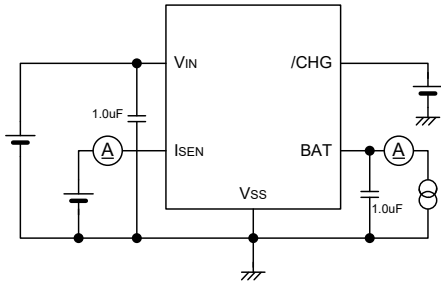

2. Battery Termination Detect Time, Recharge Battery Time
C/10 Charge Termination Current Threshold1~2,
Battery Termination Voltage1

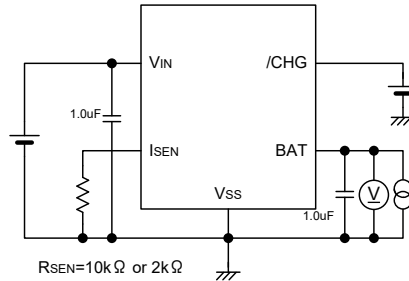

3. Trickle Charge Current1~2, Battery Current1~3, Battery Current5
 I_{SEN} Pin Voltage, Trickle Charge Voltage, UVLO,
Recharge Battery Threshold Voltage
 $V_{IN}-V_{BAT}$ Shut-down Release Voltage, /CHG Pin Weak Pull-down Current
/CHG Pin Strong Pull-down Current, Stand-by Current, Shut-down Current

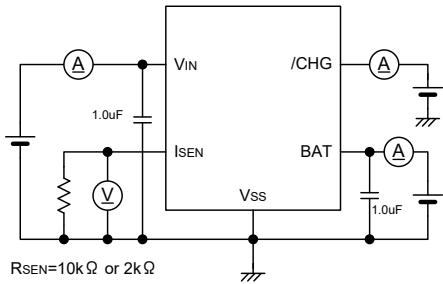

4. /CHG Pin, Output Low Voltage

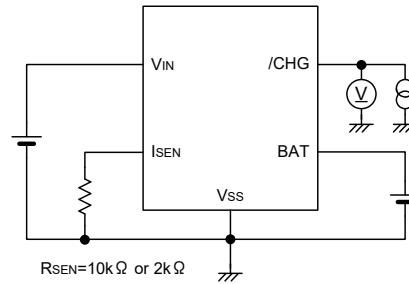

5. Battery Current 4

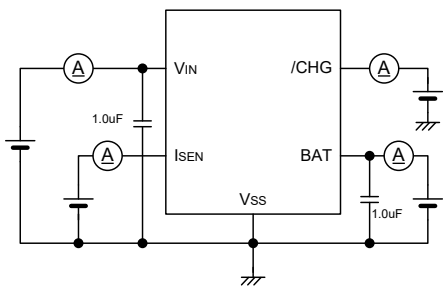

6. Soft-start

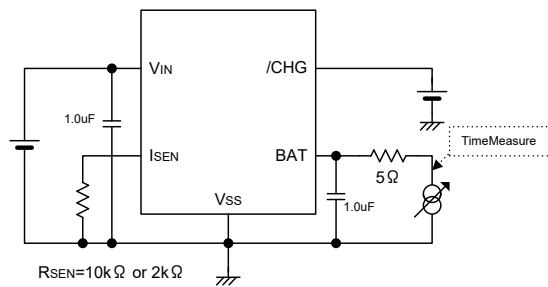

TYPICAL PERFORMANCE CHARACTERISTICS

(1) Charge Cycle

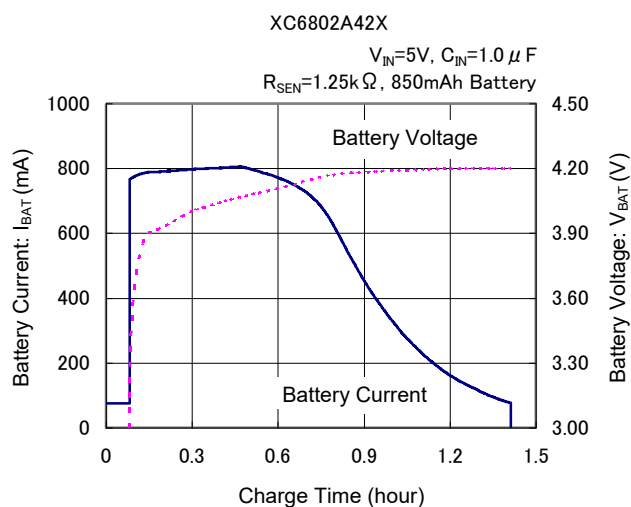
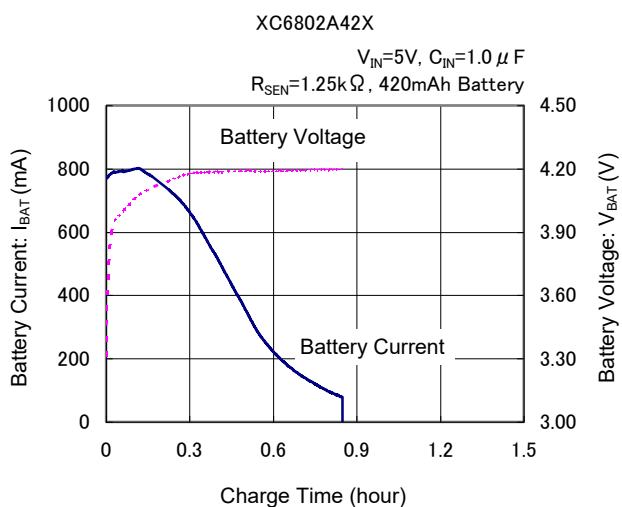

(2) Battery Current vs. Battery Voltage

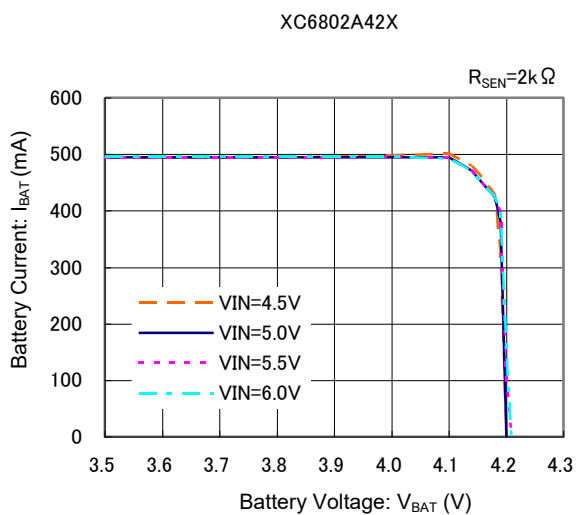
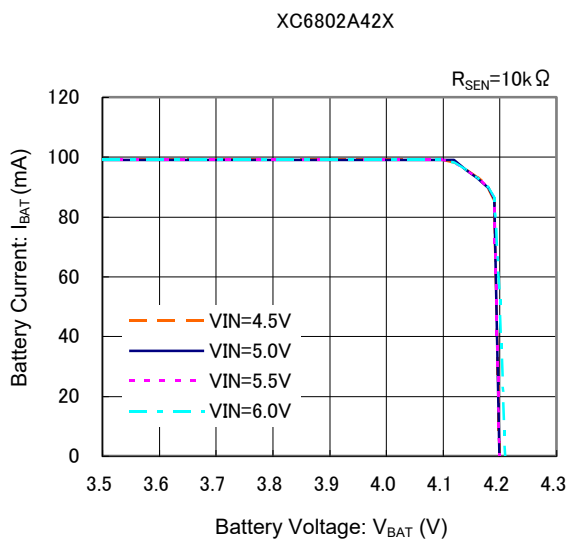
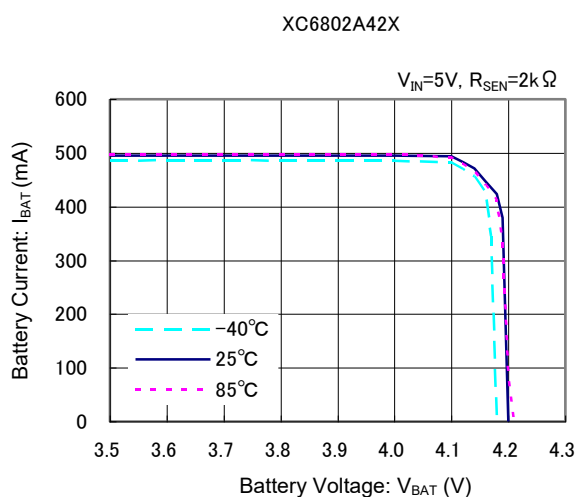
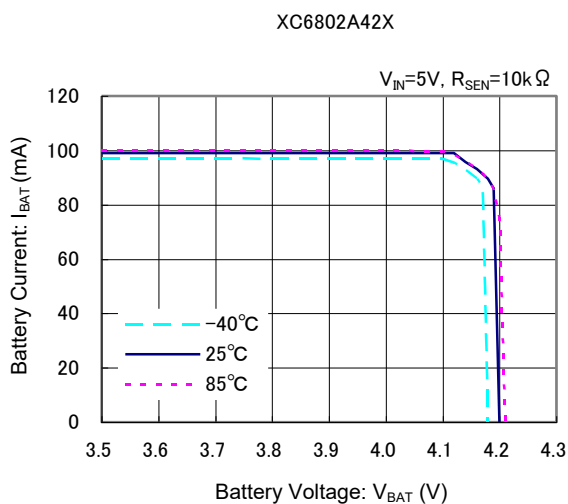

TYPICAL PERFORMANCE CHARACTERISTICS (Continued)

(3) Battery Voltage vs. Battery Current

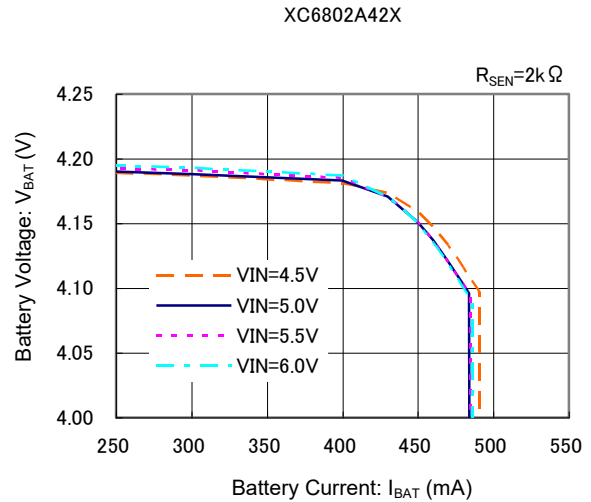
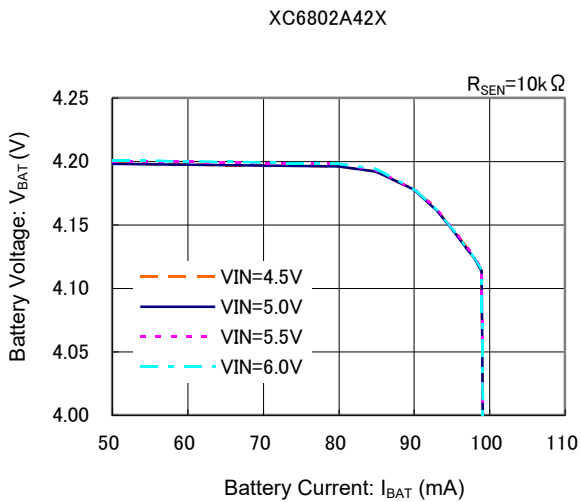
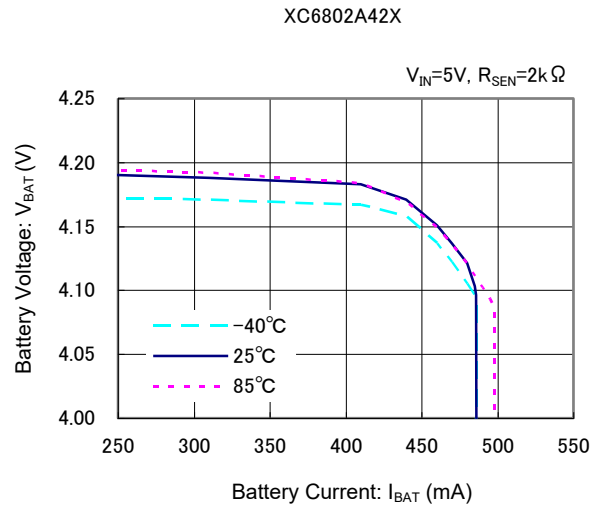
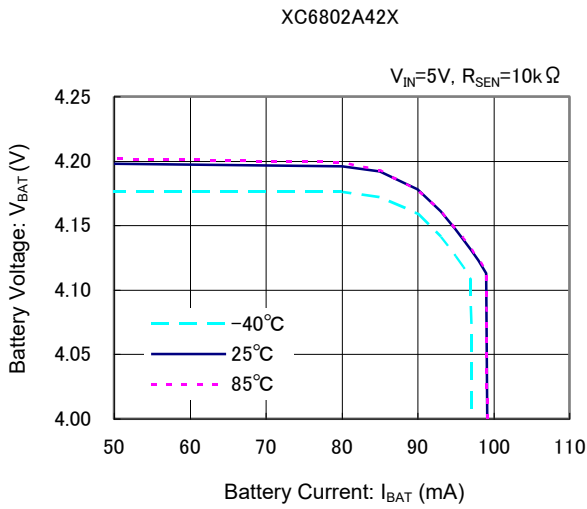

(4) Charge Termination Voltage vs. Ambient Temperature

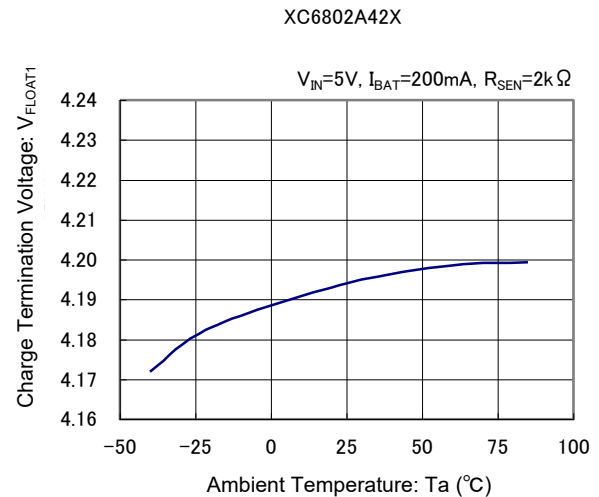
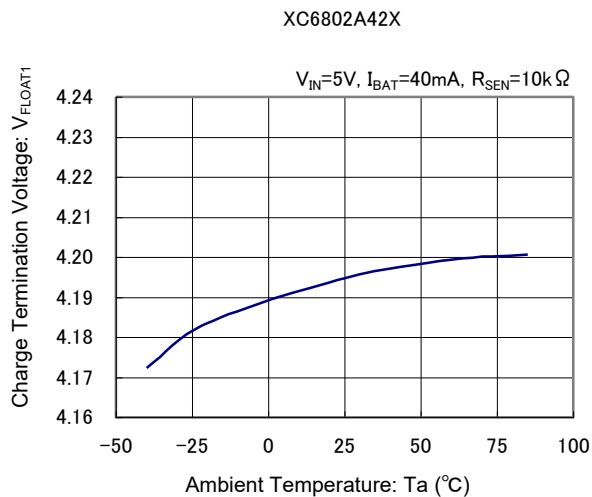

■ TYPICAL PERFORMANCE CHARACTERISTICS (Continued)

(5) Battery Current vs. Ambient Temperature

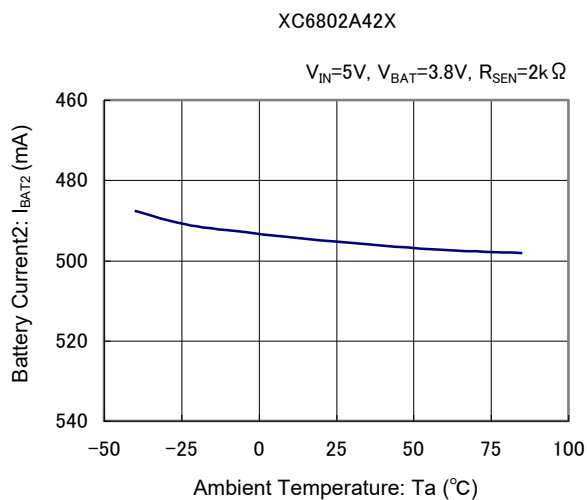
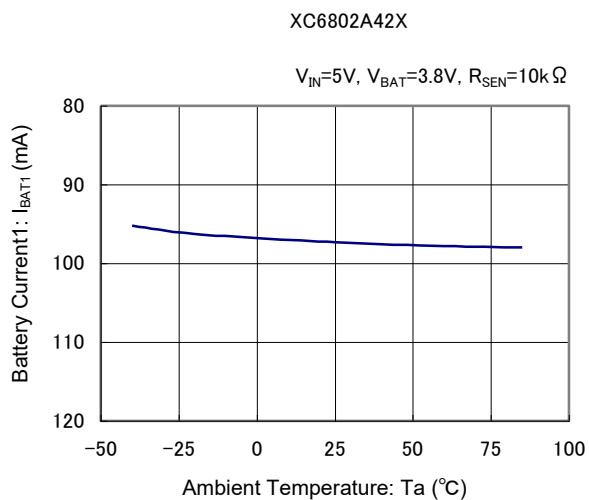

(6) Trickle Charge Current vs. Ambient Temperature

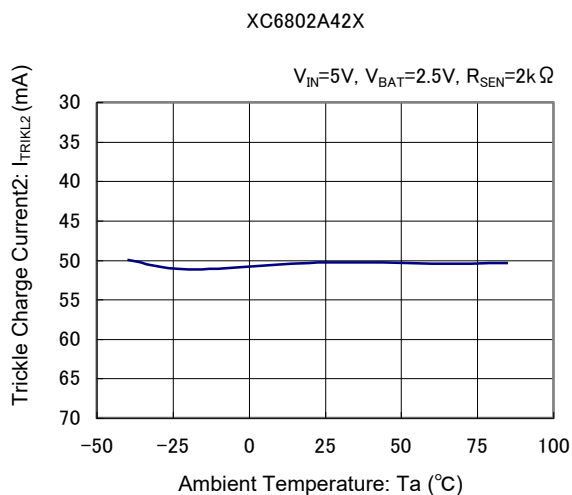
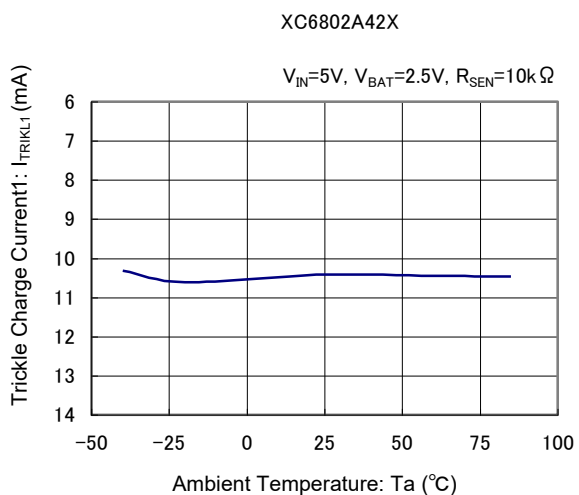

(7) Trickle Voltage vs. Ambient Temperature

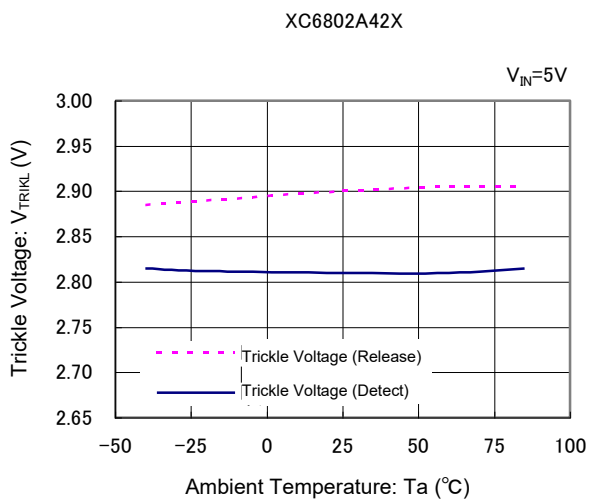

(8) Manual Shutdown Voltage vs. Ambient Temperature

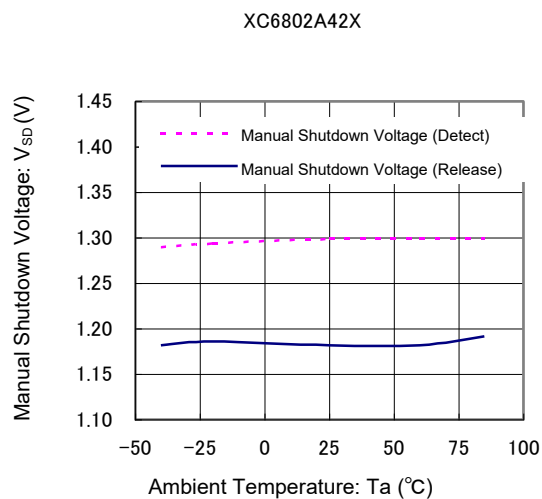

TYPICAL PERFORMANCE CHARACTERISTICS (Continued)

(9) UVLO Voltage vs. Ambient Temperature

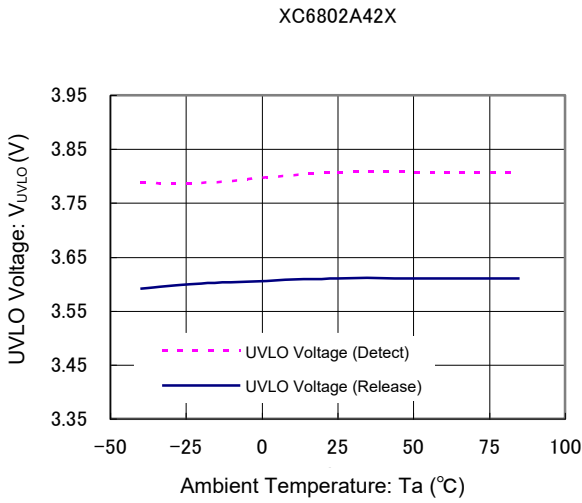

(10) $V_{IN} - V_{BAT}$ Shutdown Voltage vs. Ambient Temperature

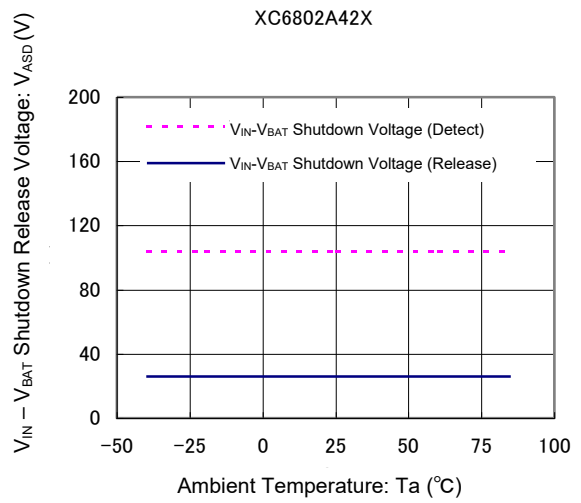

(11) Charge Termination Detect Time vs. Ambient Temperature

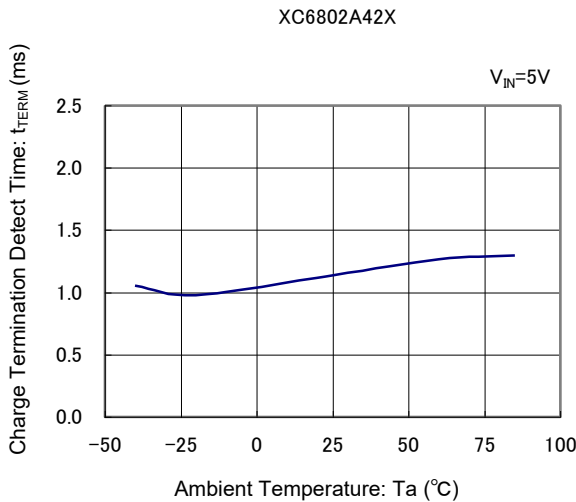

(12) Recharge Time vs. Ambient Temperature

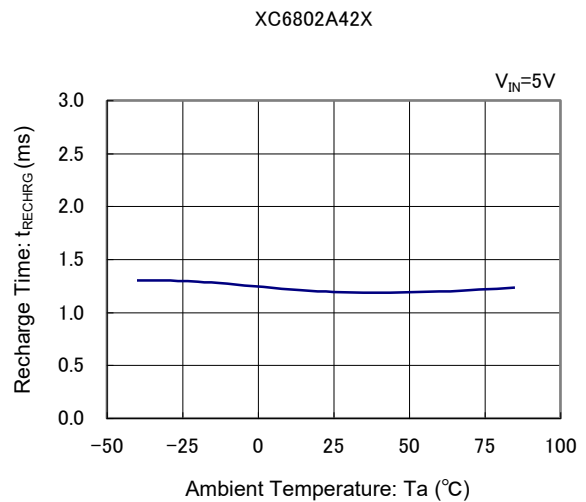

(13) Recharge Threshold Voltage vs. Ambient Temperature

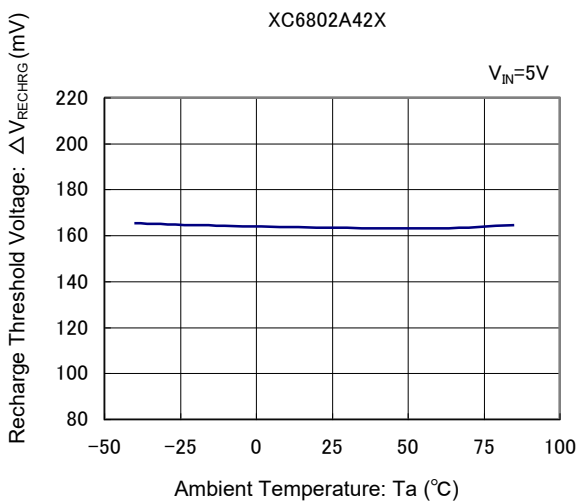

(14) Soft Start Time vs. Ambient Temperature

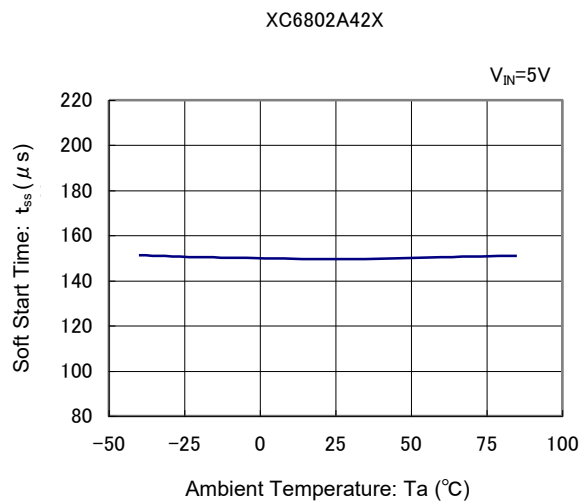

■ TYPICAL PERFORMANCE CHARACTERISTICS (Continued)

(15) ON Resistance vs. Ambient Temperature

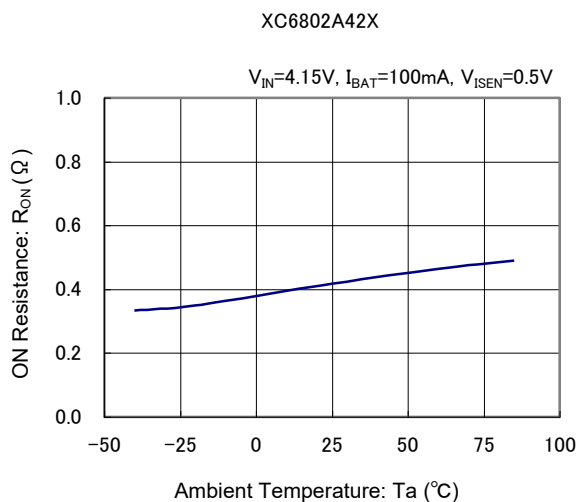

(16) Shutdown Current vs. Ambient Temperature

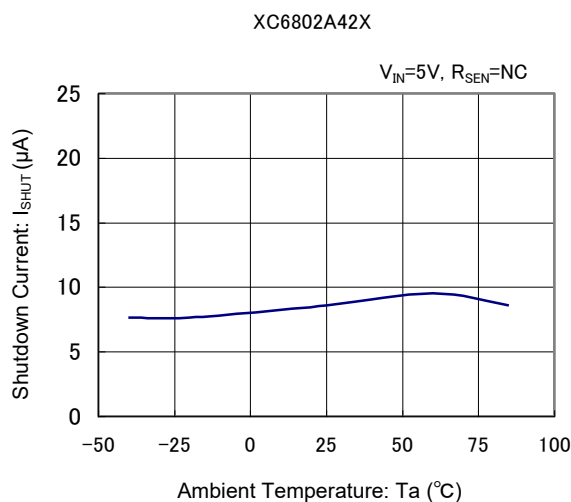

(17) Stand-by Current vs. Ambient Temperature

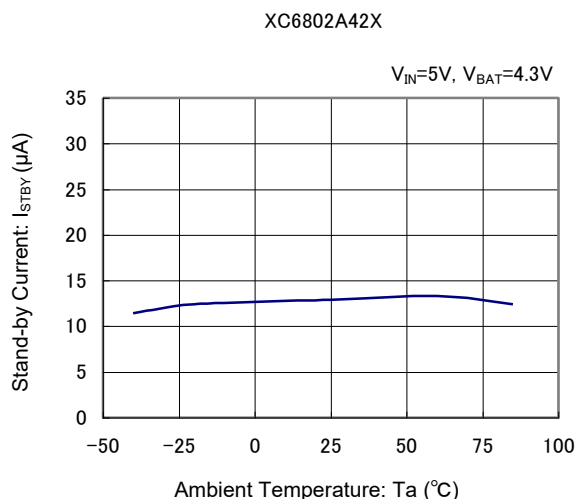

(18) /CHG Weak Pull Down Current vs. /CHG Pin Voltage

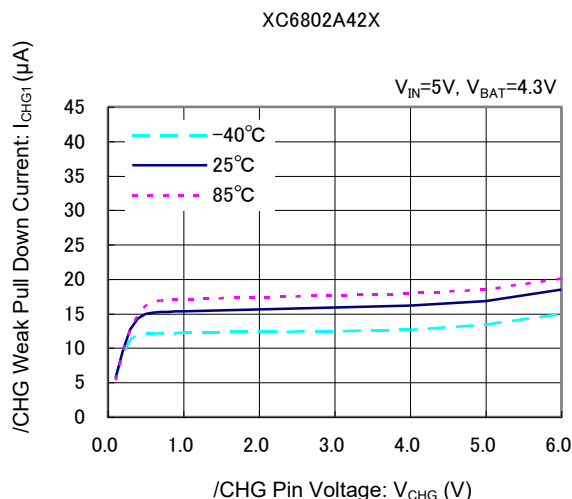

(19) /CHG Strong Pull Down Current vs. /CHG Pin Voltage

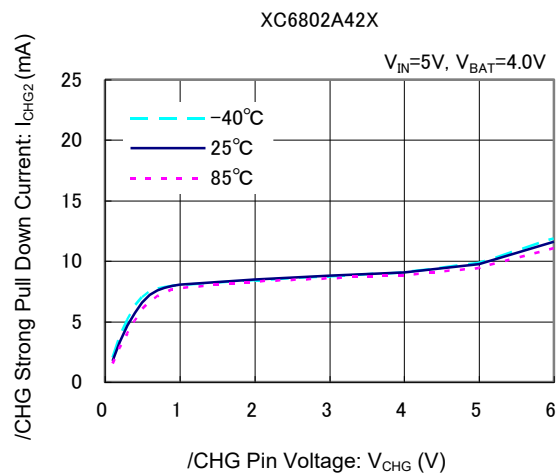

(20) /CHG Pin Output Low Voltage vs. Ambient Temperature

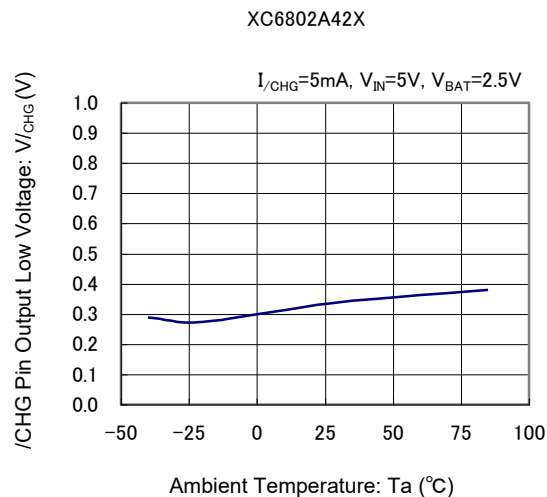

■ PACKAGING INFORMATION

For the latest package information go to, www.torexsemi.com/technical-support/packages

PACKAGE	OUTLINE / LAND PATTERN	THERMAL CHARACTERISTICS
SOT-25	SOT-25 PKG	SOT-25 Power Dissipation
SOT-89-5	SOT-89-5 PKG	SOT-89-5 Power Dissipation
USP-6C	USP-6C PKG	USP-6C Power Dissipation
USP-6EL	USP-6EL PKG	USP-6EL Power Dissipation

MARKING RULE

USP-6C / USP-6EL

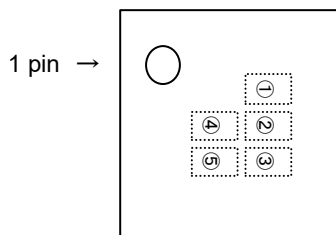

① Represents product series

MARK	PRODUCT SERIES
N	XC6802*****-G

② Standard product, Represent the 7th digits

MARK	PRODUCT SERIES
A	XC6802A*****-G

SOT-25

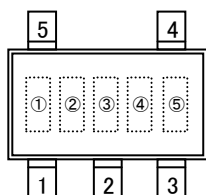

③ Standard product, Represents the 8th digits

MARK	PRODUCT SERIES
4	XC6802*4****-G

④⑤ Represents production lot number

01 to 09, 0A to 0Z, 11 to 9Z, A1 to A9, AA to AZ, B1 to ZZ in order.

(G, I, J, O, Q, W excepted)

*No character inversion used.

SOT-89-5

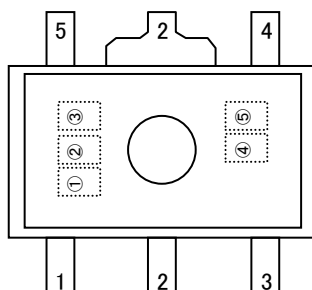

1. The product and product specifications contained herein are subject to change without notice to improve performance characteristics. Consult us, or our representatives before use, to confirm that the information in this datasheet is up to date.
2. The information in this datasheet is intended to illustrate the operation and characteristics of our products. We neither make warranties or representations with respect to the accuracy or completeness of the information contained in this datasheet nor grant any license to any intellectual property rights of ours or any third party concerning with the information in this datasheet.
3. Applicable export control laws and regulations should be complied and the procedures required by such laws and regulations should also be followed, when the product or any information contained in this datasheet is exported.
4. The product is neither intended nor warranted for use in equipment of systems which require extremely high levels of quality and/or reliability and/or a malfunction or failure which may cause loss of human life, bodily injury, serious property damage including but not limited to devices or equipment used in 1) nuclear facilities, 2) aerospace industry, 3) medical facilities, 4) automobile industry and other transportation industry and 5) safety devices and safety equipment to control combustions and explosions. Do not use the product for the above use unless agreed by us in writing in advance.
5. Although we make continuous efforts to improve the quality and reliability of our products; nevertheless Semiconductors are likely to fail with a certain probability. So in order to prevent personal injury and/or property damage resulting from such failure, customers are required to incorporate adequate safety measures in their designs, such as system fail safes, redundancy and fire prevention features.
6. Our products are not designed to be Radiation-resistant.
7. Please use the product listed in this datasheet within the specified ranges.
8. We assume no responsibility for damage or loss due to abnormal use.
9. All rights reserved. No part of this datasheet may be copied or reproduced unless agreed by Torex Semiconductor Ltd in writing in advance.

TOREX SEMICONDUCTOR LTD.