

XCL105D331H2-G Evaluation Board User Manual

Inductor Built-in Step-up “micro DC/DC” Converter (micro DC/DC)

CAUTION

ENGINEERING EVALUATION PURPOSES ONLY

This evaluation board is made for the purpose of the product evaluation. It is strictly prohibited to use this evaluation board for any other purpose.

Torex Semiconductor does not guarantee that all samples will perform in exactly the same way and we recommend that you always consult our product data sheets for the minimum and maximum specifications.

It is also important that you evaluate all our products carefully before mass production and in case of any doubt, please contact your Torex representative.

XCL105D331H2-G Evaluation Board

Inductor Built-in Step-up "micro DC/DC" Converter (micro DC/DC)

Evaluation Board Picture



Evaluation Board SPEC

						Ta=25°C
		CONDITON.	MIN.	TYP.	MAX.	UNIT
Vin	Input Voltage Range	-	0.65	-	6.0	V
Vout	Setting Output Voltage	-	-	3.3	-	V
Iout	Output Current	-	Refer to Graph 7			mA
fosc	Switching frequency	-	-	1.2	-	MHz

XCL104/XCL105 Series Features

- Input Voltage Range 0.65V ~ 6.0V
- Operation Start Voltage 0.9V
- Output Voltage Range 1.8V ~ 5.5V (step 0.1V)
- Switching frequency 1.2MHz

- Selectable depending on the application
 - Load Disconnection (A/D/G/J)
 - Bypass(XCL105B/E/H/K)
 - OR Connection (XCL105C/F/M/L)

- Built-in Inductor / Small Solution Size
- Low EMI

XCL105D331H2-G Evaluation Board

Inductor Built-in Step-up "micro DC/DC" Converter (micro DC/DC)

Quick Start Procedure

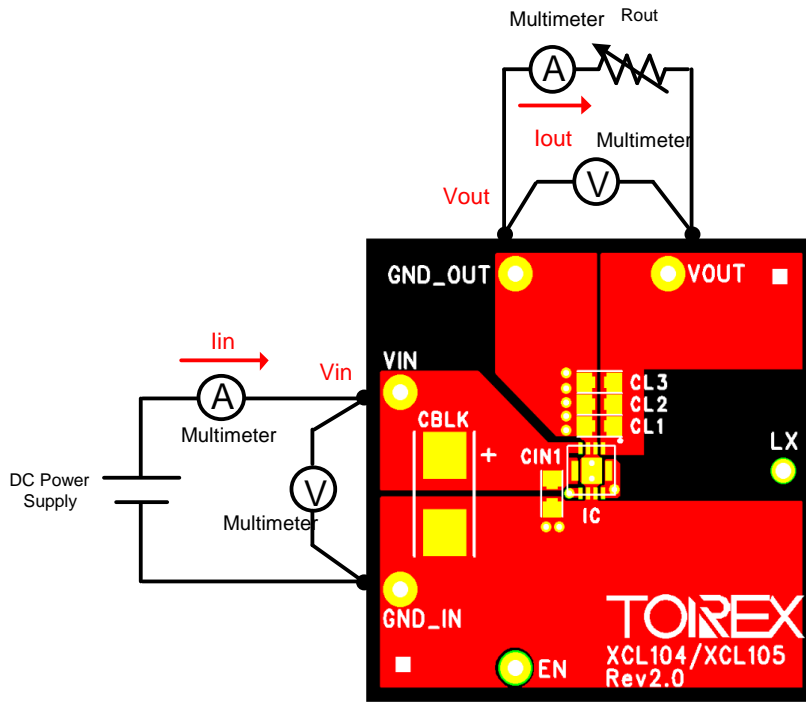

XCL105D331H2-G Evaluation Board

Inductor Built-in Step-up "micro DC/DC" Converter (micro DC/DC)

Schematic

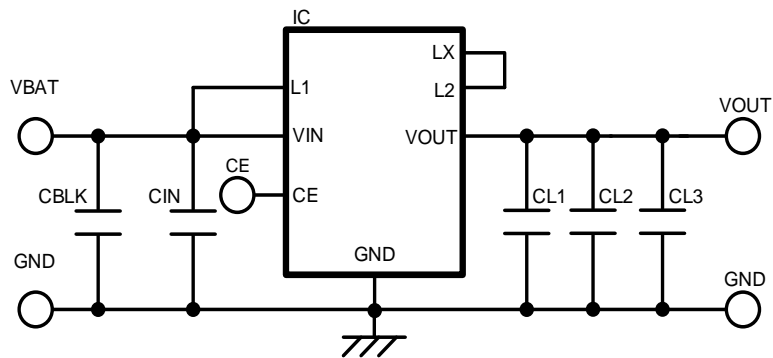

BOM

Required Circuit Component

Item	Value	Description	Size [mm]	Part Number	Manufacture
IC	-	Step-up micro DC/DC converter	DFN3030-10B	XCL105D331H2-G	TOREX
CIN	10uF	Ceramic cap., 10V/10uF	1608	GRM188D71A106MA	Murata
CL1	10uF	Ceramic cap., 10V/10uF	1608	GRM188D71A106MA	Murata
CL2	10uF	Ceramic cap., 10V/10uF	1608	GRM188D71A106MA	Murata
CL3	10uF	Ceramic cap., 10V/10uF	1608	GRM188D71A106MA	Murata

Additional Demo Board Circuit Components

Item	Value	Description	Size [mm]	Part Number	Manufacture
CBLK	-	-	-	-	-

XCL105D331H2-G Evaluation Board

Inductor Built-in Step-up "micro DC/DC" Converter (micro DC/DC)

PCB Layout

Layer 1

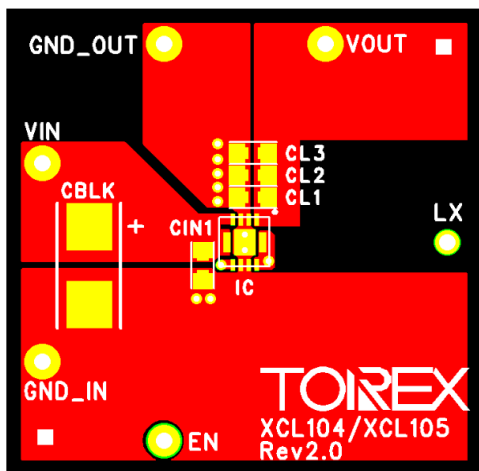

Layer 2

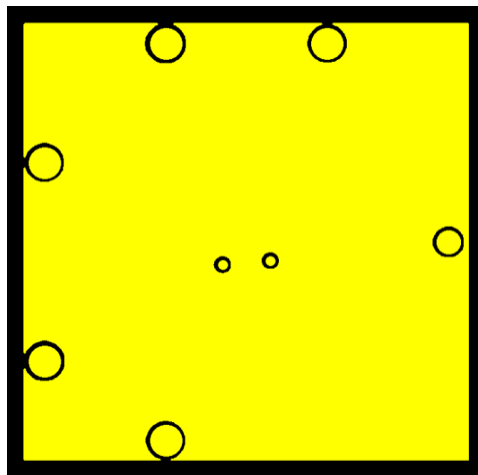

Layer 3

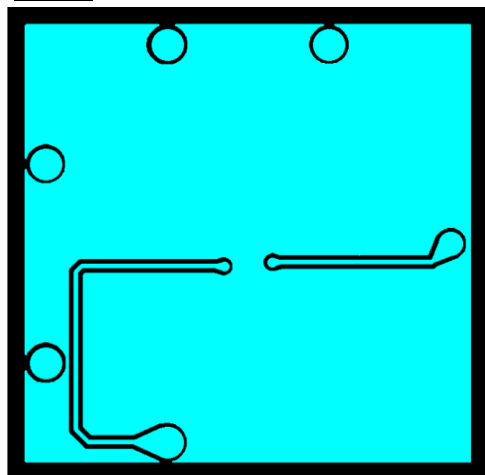

Layer 4

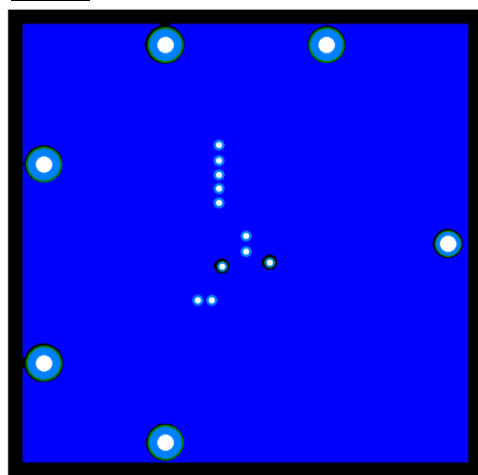

XCL105D331H2-G Evaluation Board

Inductor Built-in Step-up "micro DC/DC" Converter (micro DC/DC)

Test Result

(1) Output Voltage vs Output Current @Ta=25°C

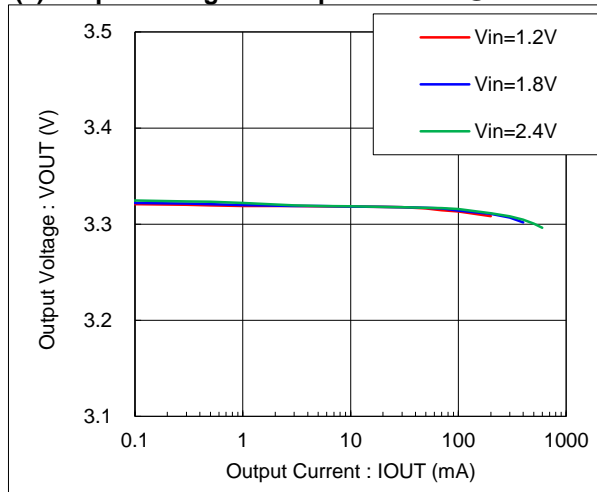

(2) Efficiency vs Output Current Ta=25°C

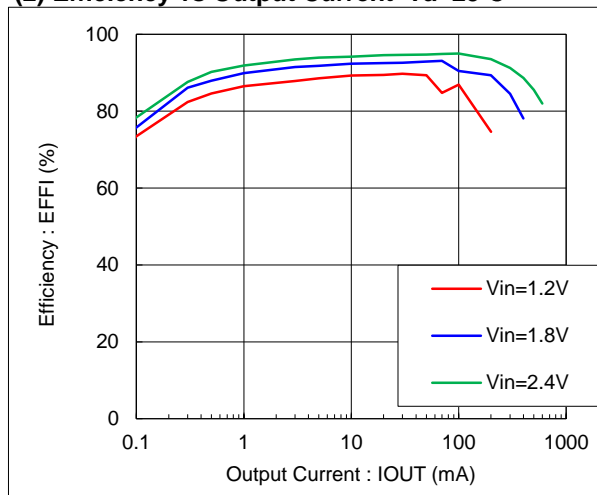

(3) Ripple Voltage vs Output Current Ta=25°C

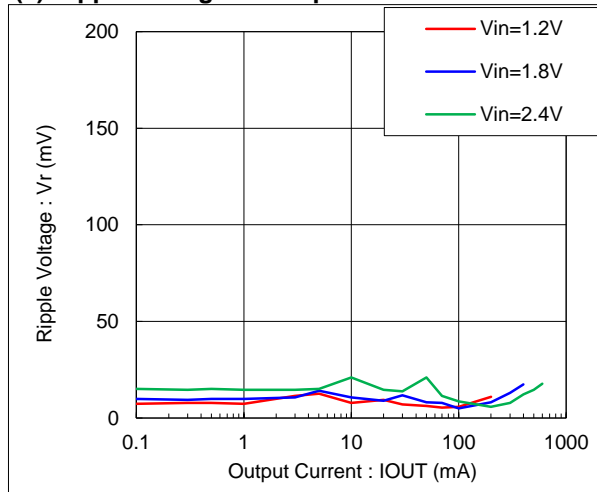

XCL105D331H2-G Evaluation Board

Inductor Built-in Step-up "micro DC/DC" Converter (micro DC/DC)

(7) Max Output Current vs BAT Voltage(Input Voltage) @ Ta=25°C

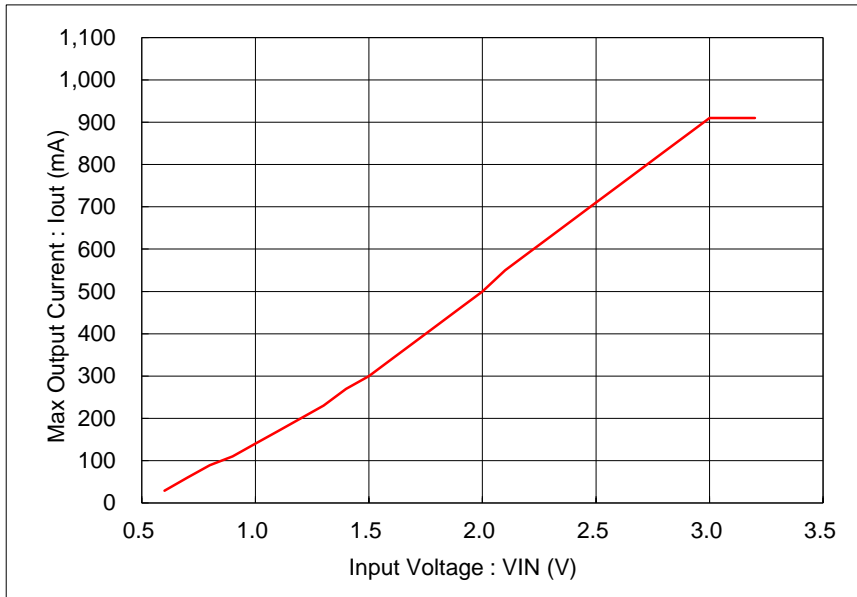

XCL105D331H2-G Evaluation Board

Inductor Built-in Step-up "micro DC/DC" Converter (micro DC/DC)

【Appendix】 How to calculate DC/DC Converter or DC/DC Controller.

It can be calculated by the following "WEB DC/DC Simulation".

Product	XC9145 Product Info
Switching frequency	1200 [kHz]
Control Method	PWM/PFM
Sim Condition	
Vin	3.3 [V] Range: 0.65V~5.5V
Vout	5 [V] Range: 3V~5.5V
Iout	30 [mA] Range: 0mA~
Rvin (Battery Impedance etc)	0 [Ω]
Ta	25 [°C] Range: -40~85°C
Thermal resistance: Bja	83.33 [°C/W] Range: 0~1000°C/W
External Components	
L	4.7 [μH]
DCR	28.5 [mΩ]
CL (Effective Value)	10 [μF]
ESR	2.5 [mΩ]

Schematic Summary	Waveform	Efficiency Tj, Duty	Ripple Voltage Vin Voltage	Coil Current Input Current	Switching frequency
-------------------	----------	---------------------	----------------------------	----------------------------	---------------------

This result consists of TYP data which does not account for variations in ICs. Inconsistencies in IC production may cause the maximum output current to decrease to a value below this result.

Schematic

Summary

Iout max :	660 [mA]
Summary@Iout=30mA	
Efficiency :	94.27 [%]
IC Loss :	7.821 [mW]
Inductor Loss :	1.283 [mW]
Tj :	25.65 [°C]
Input Current :	48.21 [mA]
Peak Coil Current :	200 [mA]
Bottom Coil Current :	0 [mA]
MODE :	PWM/PFM_DCM
Switching frequency :	582 [kHz]
Duty :	16.71 [%]
Ripple Voltage :	4.215 [mV]
Input Power :	0.1591 [W]
Output Power :	0.15 [W]
Vin Pin :	3.3 [V]
On time :	0.2871 [us]
Off time :	0.5414 [us]

- 日本語 : <https://www.torex.co.jp/technical-support/dcdc-simulation/>
- English : <https://www.torexsemi.com/technical-support/dcdc-simulation/>
- 简体中文 : <https://www.torex.com.cn/technical-support/dcdc-simulation/>

XCL105D331H2-G Evaluation Board

Inductor Built-in Step-up "micro DC/DC" Converter (micro DC/DC)

[Appendix] How to reduce the spike noise caused by measurement (Probing method with oscilloscope)

Probing method : Before improvement

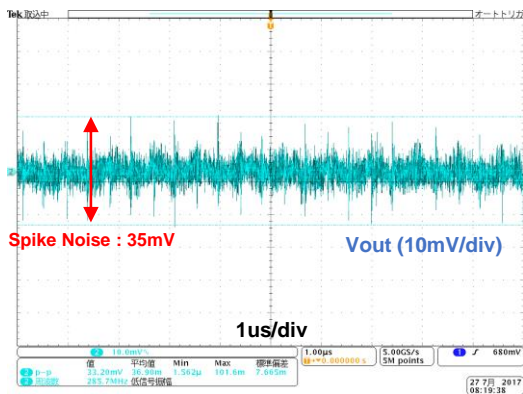
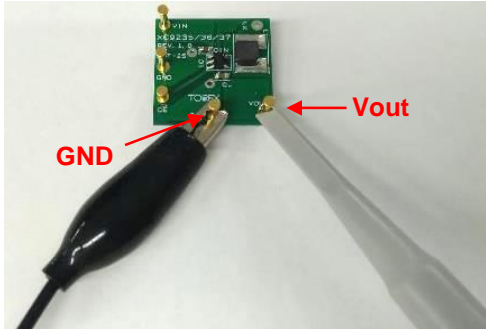

Probing method : After

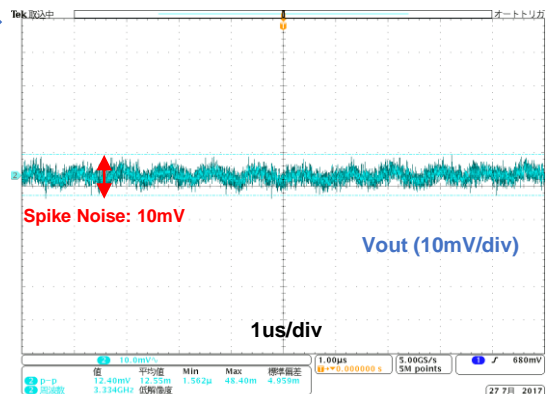
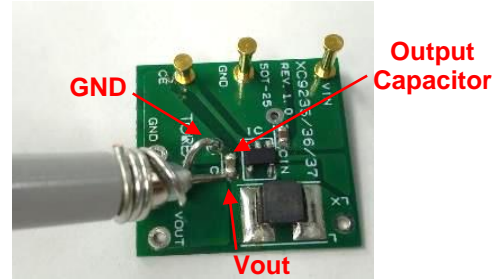

* Condition : XC9236, Vin=3.6V/Vout=1.8V/100mA

English : <https://www.torexsemi.com/technical-support/tips/reduction-spike-noise/>

日本語 : <https://www.torex.co.jp/technical-support/tips/reduction-spike-noise/>